



still... The best

The World Wide Leader
In State Of The Art
High Fidelity Technology

**Engineered and Manufactured
in the United States of America**

McIntosh Laboratory Inc.
2 Chambers Street
Binghamton, New York, 13903-9990
Phone 607-723-3512

McIntosh

TABLE OF CONTENTS

Power Amplifiers:	
MC 2500, MC 2255, MC 2250, MC 2155, MC 2120, MC 502	2-16
PreAmplifiers:	
C 33, C 29, C 27, C 504	14-24
Tuners:	
MR 80, MR 78, MR 75	25-37
Tuner-Preamplifier:	
MX 117	38-45
Receiver:	
MAC4100 AM/FM Receiver	46-50
Preamplifier- Amplifier:	
MA6200	51
Loudspeakers:	52-65
The McIntosh Story	66-67
Equalizers:	
MQ107, MQ 104	68
FM Guide	69-76

YOU SHOULD OWN

McIntosh

BECAUSE

- McIntosh instruments are designed and manufactured for long life.
- McIntosh instruments have always been designed for long life with low maintenance costs and high quality performance. McIntosh instruments have been and are the **LABORATORY STANDARD** for the world.
- Until 1949 the performance requirements for a McIntosh had long been an engineering dream. They became a reality with the introduction of the first McIntosh amplifier. Through all these years McIntosh has produced instruments that have exceptionally long life. Clinics held all over North America have shown that most of the McIntosh instruments ever manufactured still meet or exceed their original exacting specifications.
- Used McIntosh instruments have the highest resale value. Retailers report that customers are constantly searching for used McIntosh instruments. A McIntosh does not remain on the "Used" display long. You'll get more when you trade-in your McIntosh assuring you of maximum return on your investment,
- McIntosh dedication, not only to improvements, but also to fundamentals, has justified many patents on basic circuit structures as well as refinements.
- Doesn't it make good sense to deal with a company that wants to do as much for you as it possibly can?

THE *NEW* MCINTOSH AMPLIFIERS

McIntosh leadership in research and bipolar epitaxial transistor technology has produced startling new advances in safe, cool, superior performance and protection.

McIntosh engineering continues to advance power amplifier technology and protected performance. Experience and knowledge are the foundation on which the engineering superstructure is built that supports the McIntosh recognized reputation as *Laboratory Standard* for the world. A new level of technology and a higher level of amplifier performance is realized in the all new McIntosh Amplifiers.

LEADERSHIP

- McIntosh life testing selects only components that give the most trouble free performance. Added care in engineering, design and manufacturing produces long product life at the peak of performance.

LEADERSHIP

- McIntosh POWER GUARD assures maximum amplifier power without clipping distortion.

LEADERSHIP

- McIntosh engineers developed a unique output circuit configuration that is temperature stable and that delivers clean output power at any level without a trace of crossover distortion.

LEADERSHIP

- McIntosh Automatic System . Test provides positive protection and extends the long trouble free life of an amplifier. Each time an amplifier is turned on, seven tests are completed that measure and verify accurate performance.

LEADERSHIP

- McIntosh Output Autotransformers deliver full power output and multiple feedback loops assure lowest distortion at all power levels and all speaker impedances.

LEADERSHIP

- McIntosh designed mute circuits give positive protection from transients due to turn on, turn off power supply voltage changes.

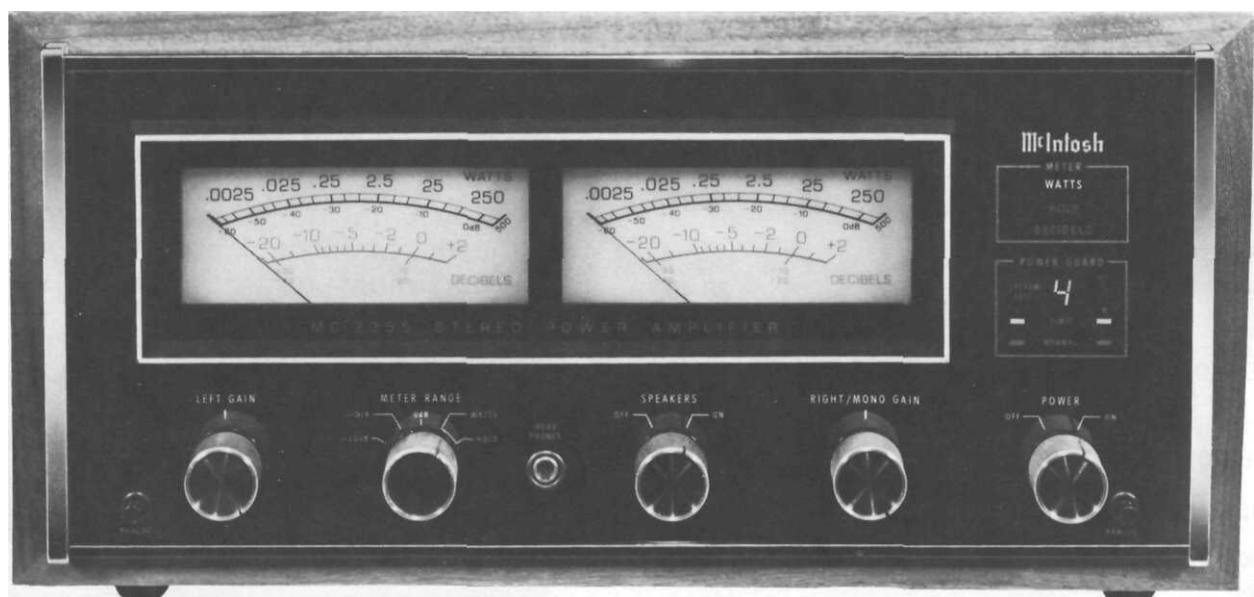

MC 2255 Shown in optional walnut veneer cabinet

YOU ARE PROTECTED FROM LISTENING TO AMPLIFIER PRODUCED DISTORTION WITH MCINTOSH POWER GUARD

Plus:

- McIntosh Output Autotransformer delivers full power output. Multiple feedback loops assure lowest distortion at all power levels and all speaker impedances
- McIntosh engineers developed a unique output stage circuit arrangement that is completely temperature accurate, that delivers clean output power at any level without crossover distortion
- McIntosh life testing of components permits component selection for trouble-free performance; added care in production engineering and manufacturing results in long product life
- McIntosh designed "turn-on/mute" circuits provide positive protection from "turn-on transients" and other potentially damaging noises
- McIntosh POWER GUARD assures maximum amplifier power without clipping distortion

Higher power demands on amplifiers have presented music listeners with a form of unpleasantness in listening, amplifier overload (hard clipping) that looks and acts like square waves. Clipping is caused when the amplifier is asked to produce more power output with low distortion than it can deliver. Clipping of a complex wave form is largely composed of odd order harmonics and intermodulation products. High order odd harmonics and intermodulation products are dissonant and are not musically related to the signal being amplified. They are heard as great and disappointing discordance and distortion.

In most acoustical events we may listen to surprisingly low average power output but the peak power requirements can be very high. Consider these graphs of the power demanded of an amplifier reproducing the piano, the pipe organ, and the bass saxophone. The charts show that the peak power demand is almost 1000 times (30 dB) the average power demand. Since it is necessary that these short interval power spikes be reproduced with low distortion, it means the average power output of the power amplifier must be limited to 1/1000th of its capability or the listener must accept the discordant distortion of clipping.

Amplifiers when driven to clipping are capable of delivering up to twice the heat load to the loudspeaker. In addition, they can have more than

40% harmonic distortion. The extra heat energy content of the clipped signal will damage most speakers. McIntosh leadership in engineering has developed a new circuit that...(1) dynamically prevents power amplifiers from being overdriven in-

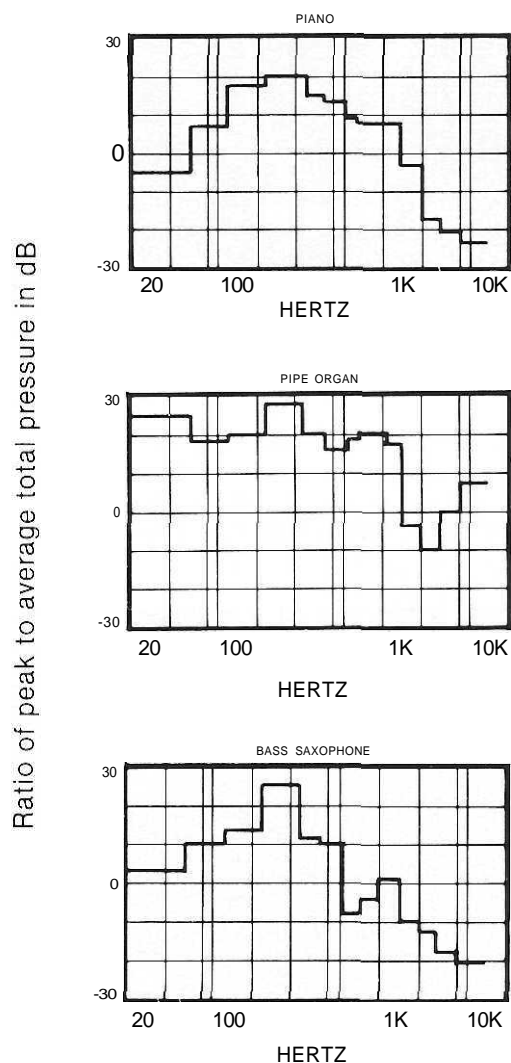

to hard clipping...(2) which reduces the heat developed in the loudspeakers...(3) assures that the amplifier will produce its maximum output without increased distortion. That circuit we call "POWER GUARD."

THE MCINTOSH POWER GUARD

The Power Guard waveform comparison circuit detects minute amounts of waveform difference between the output signal and the input signal. A sampling of the program material at the output of the amplifier is constantly compared with the program material at the amplifier input. Should the differences reach 1%, Power Guard goes to work.

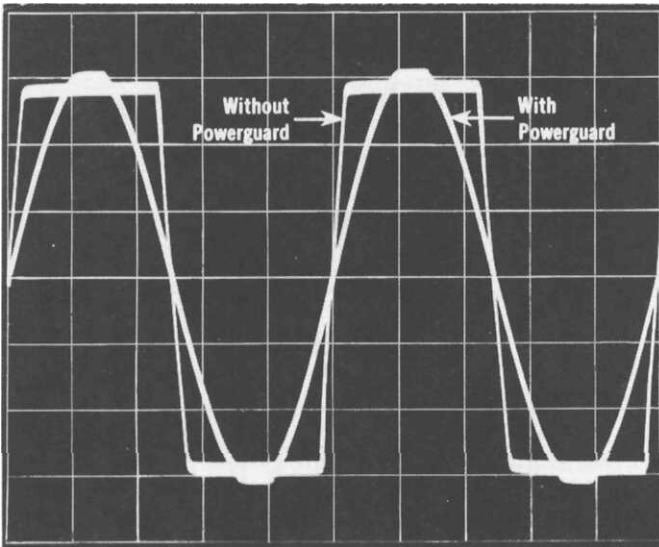

Oscillogram of output waveform with and without Power Guard. Input overdriven for each trace 20 dB.

In only a fraction of a millisecond Power Guard dynamically reduces input level to prevent amplifier overload yet permits the amplifier to deliver its absolute maximum power output without extra distortion. In addition, the output of the "waveform comparator" activates the front panel NORMAL and LIMIT indicators.

The Power Guard circuit provides a precise visual indication when the amplifier has reached full power output. Any time that the input circuit is fed excessive amounts of signal causing waveform differences through the amplifier of 0.5%, the output mode indicators change from green NORMAL to red LIMIT automatically and instantaneously. This warning persists long enough for positive visual indication of clipping for a pulse that is so infrequent or short that it would be impossible to be seen even on an oscilloscope. The indicators will illuminate on clipping for a pulse as short in time as 100 microseconds. You are always assured that the power of your amplifier is as clean and distortion free as it can be.

THE MCINTOSH POWER METERS

McIntosh developed output monitoring meters add to your operating flexibility. Ordinary meters are incapable of indicating the short interval information in a sound wave. The mass of the meter movement is too great to respond to the instantaneous changes in music program material. That short interval information can have a duration as brief as one-half of one thousandth of a second. Even should the meter be capable of the high velocity movement the human eye could not perceive the information.

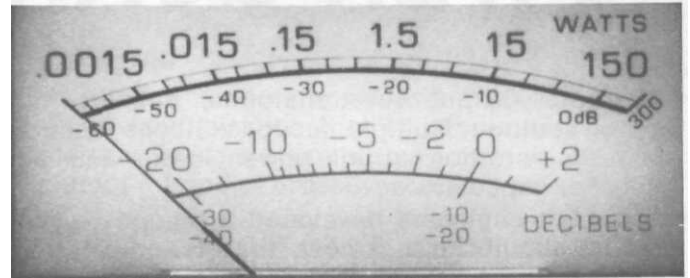

McIntosh engineering pursued both problems electrically by developing new electronic circuits that cause the meters to respond to short interval information with an accuracy of 98%! To permit the eye to see such high speed motion the electronic circuits that drive the meter pointer are time stretched so the meter pointer position can register in the persistence of vision characteristics of the human eye.

The meters indicate directly in watts, or can be made to hold the highest reading and continuously update on higher power or can be switched to be peak reading — peak locking decibel meters.

When used as a watt indicating meter all the information is direct reading, without conversions or complicated mathematics. In addition, as direct reading meters they are calibrated in average watts for a sine wave signal but respond to signal peaks.

The meters indicate direct power in watts. They are calibrated in average watts for a sine wave signal but respond to signal peaks. So, a 200 average watt indication also means 400 instantaneous peak watts. The meters are voltage actuated and indicate power accurately when the amplifier is operated into rated output load impedances.

Watts Hold, permits the meter to lock to and indicate the highest power peak in a sequence of peaks. The meter will be driven to maximum power and electronically held there until a higher peak passes through the amplifier. If no further peaks are reached the meter needle will very slowly return to a lower peak or to its rest position at a decay rate of 10 dB per minute.

The meters have extremely fast rise time, about 500 microseconds for 90% accuracy. A tone burst of 500 microseconds is almost inaudible even at full power.

The meters are protected from damage in the event of overloading in the wrong meter range.

AUTOMATIC TEST SYSTEM

The Automatic Test System provides positive protection and extends the long trouble free life of an amplifier. Each time the amplifier is turned on an Automatic Test System measures and verifies accurate performance at seven critical points in the amplifier's circuits. The Automatic Test System verification assures operational readiness before operation starts and limits any damage should there be component malfunction. Each time a test is verified an LED number indicator shows which test is being performed. An adjustable "beep" tone can be heard with each test.

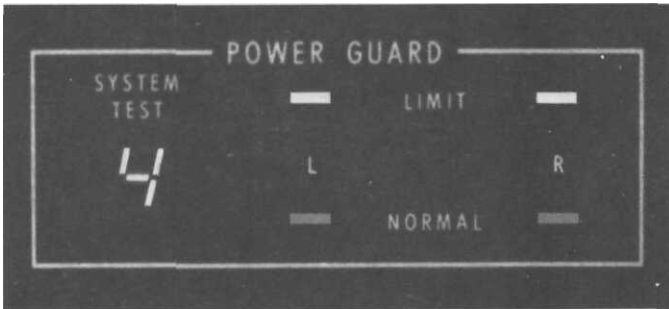

If in the testing an unacceptable voltage is encountered, the LED numeric designation locks to isolate the faulty circuit. Faulty circuit identification permits the service technician more efficient repair. Without the McIntosh Automatic Test System attempts to locate a fault by the probing and testing needed, will often create additional problems by putting undue mechanical and electrical stress on the circuit components. The Automatic Test System protects your investment.

THE MCINTOSH OUTPUT CIRCUIT DESIGN

To achieve long trouble free life in an amplifier it is essential to have cool operation. Cool operation results from the careful design of the output circuit, matching of the output circuit to the loudspeakers with an autotransformer and a mechanical design that permits the use of generous sized heat sinks providing adequate ventilation without the use of fans.

The bipolar epitaxial output transistors and the McIntosh output circuit allows the amplifier to operate as cool as possible. When there is limited program demand on the amplifier only the optimum number of output devices operate. When there is no signal no output device is conducting. Conservative McIntosh engineering keeps operating temperatures low assuring long life.

The interleaved multifilar wound McIntosh designed autotransformer transfers all the power you paid for to all impedance taps. You are not power penalized for operating at an output impedance of less than 8 ohms. The McIntosh autotransformer does its outstanding job without adding phase shift, limiting frequency response or power output. The distortion through the autotransformer is 0.003% at 20 Hz and unmeasurable at higher frequencies. In short, the McIntosh autotransformer is the ideal answer to a difficult problem.

Heat sinks must be large and they must have adequate ventilation for effective cooling. For example the MC 2255 has 1100 square inches (7.64 square feet) of radiating surface. In addition, the chassis has been designed to permit the maximum amount of air to flow over the heat sinks to conduct away the life limiting heat.

McIntosh amplifiers provide the correct connection impedance to drive numbers of speakers simultaneously. For instance the 1 ohm output will drive eight 8 ohm speakers and deliver full power without overheating.

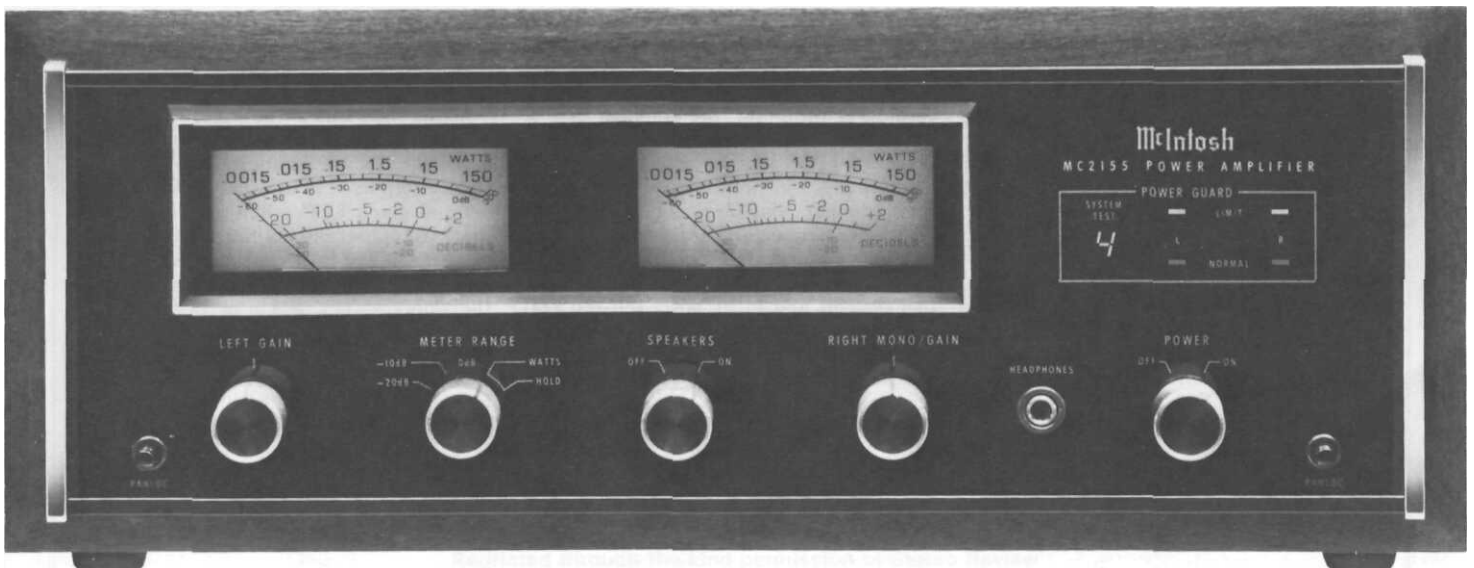

MC 2155 shown in optional walnut veneer cabinet.

"Reprinted with permission from the June 1982 issue of STEREO REVIEW magazine. Copyright © 1982 Ziff-Davis Publishing Company. All rights reserved."

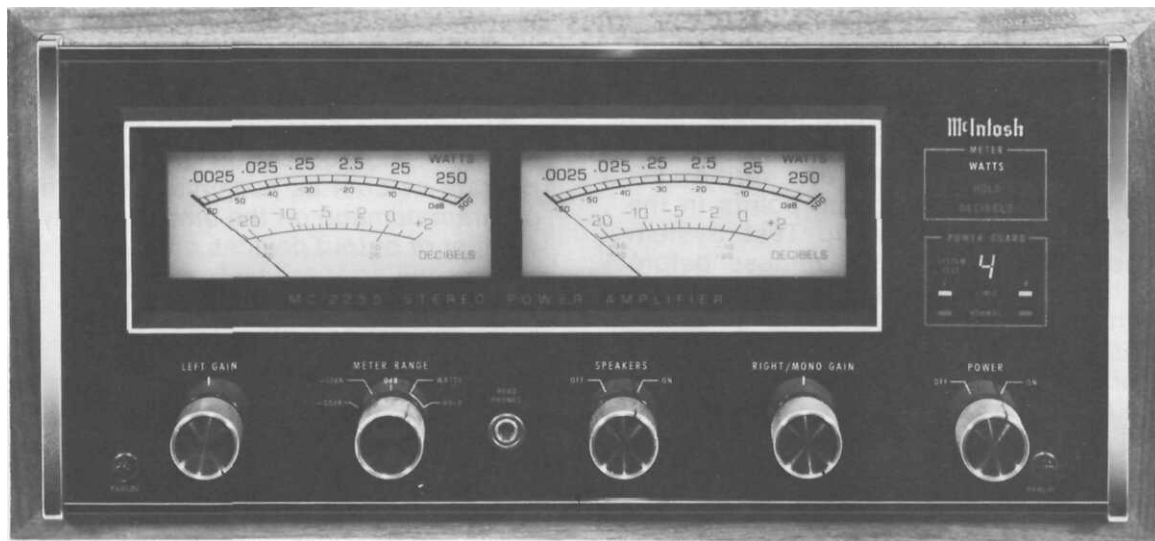

McIntosh MC 2255 Power Amplifier

- McIntosh MC 2255 Power Amplifier
- Power Rating: 250 watts per channel
- Size: 16¼ x 14¾ x 7¼ inches
- Weight: 82 pounds
- Price: \$2,750

THE McIntosh MC 2255 basic power amplifier is rated to deliver its output into loads of 1, 2, 4, or 8 ohms, from 20 to 20,000 Hz, with no more than 0.02 per cent harmonic or intermodulation distortion. Its stereo outputs may be paralleled or bridged to drive a mono load with a maximum output of 500 watts at 0.02 per cent distortion. Depending on the connection used, the mono load impedance can be from 0.5 to 16 ohms.

The unusual load capabilities of the MC 2255 derive from the use of large autotransformers to match the output transistors to their loads. Like vacuum-tube amplifiers, the MC 2255 has output terminals designated for 1, 2, 4, or 8 ohms. Thus, regardless of the speaker impedance, the output transistors are optimally loaded and can deliver their full power without excessive distortion or overheating.

The output stages of the MC 2255 operate in class-B, but a unique biasing system completely eliminates the crossover distortion usually associated with class-B operation. This being the most efficient mode of linear amplifier operation, the total power consumption of the MC 2255 from the 120-volt a.c. line is only 0.7 ampere at idle (or normal playing volume) and 12 amperes at full output. The input and driver stages form a complete class-AB low-power amplifier which drives the front-panel headphone

jack as well as the power stages. Switches connect the input sections for mono operation. In the MONO/PARALLEL mode the right-channel input drives both output sections in phase, and for the MONO BRIDGE mode the other input section is used as a phase inverter so that the outputs can be driven 180 degrees out of phase.

The power stages are protected by a novel Power Guard circuit that makes it impossible to clip the amplifier output by overdriving it. A waveform comparator monitors the input and output signals of the amplifier, and if the output waveform differs from the input by an amount corresponding to about 0.5 per cent harmonic distortion, a red LIMIT light glows on the panel (there are separate lights for the two channels). Any further increase in the drive level causes the signal to be attenuated ahead of the output section. This prevents the output from ever exceeding its linear operating range (according to McIntosh, the amplifier can be overdriven by 20 dB before distortion reaches 2 per cent).

Internally, the McIntosh MC 2255 is a very complex amplifier, containing some eighty-five transistors, forty-seven diodes, and fourteen integrated circuits. Many of its components are involved in the protective systems and in its novel self-test feature. Each time the amplifier is turned on, an automatic seven-step test sequence checks the key operating voltages for correctness. As each step is executed, the corresponding numeral lights up on a front-panel display and a green light signals that it has been passed. If any stage of the test is not satisfactory, its number remains lit to

indicate the problem area. Two different test speeds can be selected, and one can choose to have a "beep" sound after each step or to have the tests proceed in silence.

Two large meters are calibrated logarithmically from less than 2.5 milliwatts to 500 watts output (because of the output transformers, these readings are equally applicable to any of the load impedances for which the amplifier is designed). Another scale reads in decibels from -20 to +2 (the latter corresponding to about 250 watts output). Knobs below the meters control LEFT GAIN, RIGHT/MONO GAIN, METER RANGE (-20 dB, -10 dB, 0 dB, WATTS, HOLD), the SPEAKERS outputs, and POWER. The HOLD position of the METER RANGE switch causes the meters to retain their highest readings. The meter-driving circuits allow them to respond to very short program peaks, although they are calibrated in average watts.

At the right side of the panel are the two indicator groups. The POWER GUARD display shows the number of the SYSTEM TEST sequence step as it is executed, and pairs of red and green LEDs show either that the LIMIT (of output power) has been exceeded or that the amplifier operation is NORMAL. Above this group, a meter group illuminates the words WATTS, HOLD, or DECIBELS, according to the setting of the METER RANGE switch.

On the rear of the chassis are two sets of barrier terminal strips for the speaker outputs, a single unswitched a.c. outlet, and the holder for the 15-ampere line fuse. A three-position MODE switch selects STEREO, MONO BRIDGE, or MONO PARALLEL operation. Next

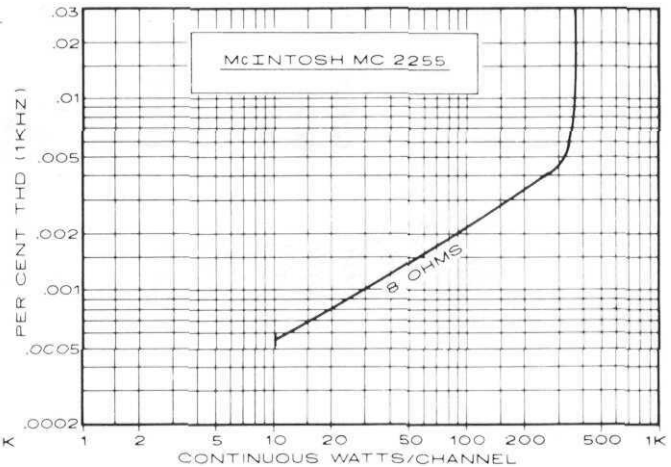
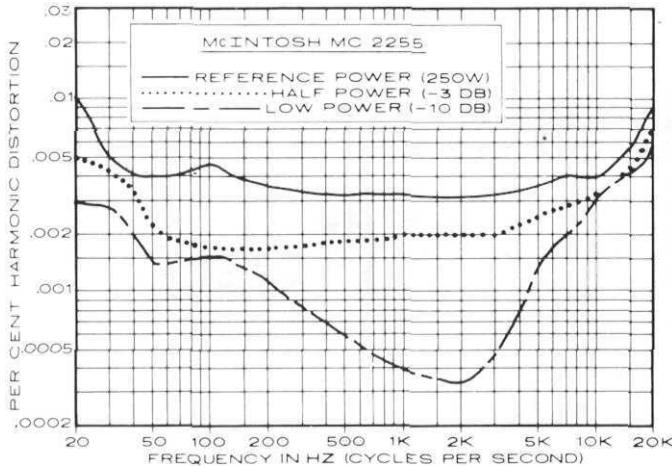

to the two input phono jacks is a switch that sets the input sensitivity to either 0.75 or 2.5 volts for full output depending upon the associated equipment. (The latter is the normally preferred setting for most setups.)

The MC 2255 is a handsome and rugged amplifier, following a long-standing McIntosh tradition in its styling and construction. The panel and most of the top metalwork are finished in black, with front accents of silver and softly lit blue-green meters. The chassis is chrome-plated. Also furnished with the amplifier are side brackets and hardware for the McIntosh Panloc system for custom installations.

McIntosh MC 2255 Power Amplifier

Comment. McIntosh (one of the oldest names in hi-fi, and perhaps the only firm from its time to remain under the original ownership) has earned an impressive reputation for their continued support of their products, their exceptionally conservative design and specifications, and generally outstanding quality. The MC 2255, the first McIntosh product we have reviewed in many years, is a perfect example of the continuation of those policies.

In its circuitry and operating features, the MC 2255 is quite unlike any other basic power amplifier we have seen. By using autotransformers to match the load impedance to the transistor requirements, McIntosh has made an amplifier capable of delivering its full potential performance into almost any load impedance it might encounter. That performance, as our tests have shown, is absolutely first-rate. It is difficult to imagine any home installation needing more

Laboratory Measurements. Preconditioning the MC 2255 at one-third rated power made the heat sinks very hot, but the rest of the amplifier remained comfortably cool throughout our tests. In normal operation the MC 2255 is no more than faintly warm and has no need of a cooling fan or any unusual ventilation precautions.

With both channels driving 8-ohm loads at 1,000 Hz the distortion was undetectable (well below the noise level) until we reached 10 watts output, when it measured 0.00056 per cent. It increased very gradually with higher power to 0.0032 per cent at 250 watts and 0.0045 per cent at 300 watts. The

power than the MC 2255 delivers with such apparent ease. Its noise, distortion, stability, and any other quality one might name are quite literally "state of the art."

The Power Guard system is most effective in making it impossible to hard-clip the output of the amplifier. Regardless of how hard it is driven, it simply cannot develop an audible amount of distortion on musical program material (2 per cent is well below the probable threshold of audibility of distortion in a music system being driven to 350-plus watts). This feature should also mean a greatly reduced likelihood of blowing out a speaker, since clipping is a common cause of tweeter damage. For the nontechnical user, the self-test feature is mostly a "security blanket," although we can appreciate that it would also simplify troubleshooting and servicing.

CLEARLY, no effort has been spared in the design and construction of this amplifier. This sort of perfectionism carries a considerable price, both in dollars and pounds (avoirdupois, not sterling!). Considering the probable long life of the MC 2255, that price does not seem at all unreasonable. *-Julian D. Hirschi*

maximum power (corresponding to "clipping power," except that the waveform could not be made to clip) was about 357 watts, with distortion reading 0.24 per cent at the limiting point. The output into 4 ohms (using the appropriate output terminals) was also 357 watts, and we were able to develop 420 watts per channel into 2-ohm loads.

At the rated 250 watts output into 8 ohms, the maximum distortion was 0.01 per cent at 20 Hz. Over most of the audio range it was about 0.004 per cent, rising to 0.009 per cent at 20,000 Hz. At lower power outputs the distortion was substantially lower. The amplifier sensitivity (using the 2.5-volt reference output, and the A-weighted noise and hum level was 86 dB below 1 watt. The frequency response of the amplifier was within +0. - 0.1 dB from 20 to 20,000 Hz and was down 0.9 dB at 5 Hz and 3 dB at 150 kHz.

The amplifier rise time was about 3 microseconds, and its IHF slew factor was about 10. The IHF intermodulation distortion, measured with 18- and 19-kHz signals, was -94 dB for the second-order component at 1,000 Hz and -67 dB for each of the third-order products at 17 and 20 kHz, all being referred to a 250-watt level.

The clipping headroom of the amplifier was 1.55 dB for 4- and 8-ohm loads and 2.55 dB for 2-ohm loads. The dynamic power output was 455 to 466 watts, depending on the load impedance, giving dynamic-headroom ratings of 2.65, 2.7, and 2.5 dB for loads of 8, 4, and 2 ohms, respectively.

The meters read quite accurately (about 0.2 dB high at full power) and responded to very brief transient signals. They are driven from the class-AB input amplifier instead of from the output stages as in most amplifiers, so the meter readings are unaffected by switching off the speakers. We found the headphone volume to be only marginally useful with 600-ohm phones. It was adequate with conventional-impedance phones.

Output Transformers in Transistor Power Amplifiers

by Sidney Corderman*

Output transformers can make transistor power amplifiers more reliable, more flexible, and more powerful. At the same time output transformers offer the best continuous protection to loudspeakers against the hazards of avalanche failure of output transistor devices.

Time has shown that output transformers make transistor amplifiers operate cool and safe. The output transformerless amplifier (OTL) becomes less exciting when amplifiers must give long, consistent and predictable operation.

Let's take a look at transformers in general—at their past and present use in amplifiers - - - and at why McIntosh Laboratory continues to be the leader in the amplifier field with the use of transformers.

Remember Vacuum Tube Amplifiers?

Until the early 1960's, McIntosh and just about everyone else in the high fidelity component manufacturing business produced vacuum tube power amplifiers exclusively. The familiar push-pull circuit of Fig. 1 reigned supreme. In that circuit we had a pair of tetrode or pentode tubes with their high output impedance trying to deliver power to low impedance loudspeaker systems. A transformer was needed to provide the necessary impedance match between them. But there were problems in trying to achieve an optimum transfer of power between tubes and speakers. Typically, using a pair of 6L6 output tubes in

push pull, we had a tube load impedance of 4000 ohms trying to deliver

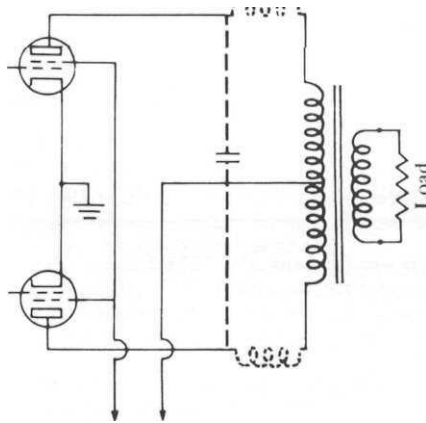

Fig. 1 — Typical push — pull output circuit (see story for dashed line information)

power to, say, an 8 ohm speaker load. The impedance ratio was 500 to 1, and the necessary transformer had to have a turns ratio of around 23 to 1 (turns ratio varies as the square root of the impedance ratio). The required turns ratio created problems at both ends of the audio frequency spectrum. Leakage inductance and shunt capacitance (represented as dashed lines in Fig. 1) caused high frequency roll-off. The primary inductance of the transformer together with its inherent non-linear characteristics placed limits on low-frequency response. And the energy stored in the unwanted leakage inductance caused notch distortion, as illustrated in Fig. 2.

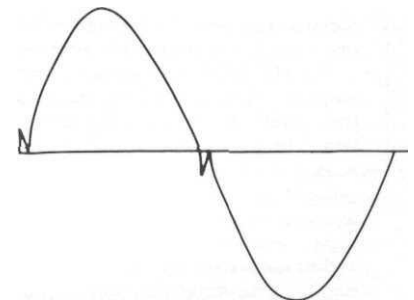

Fig. 2 - Notch distortion in a typical Class B output circuit

The McIntosh Unity Coupled Circuit

Long before the advent of transistorized power amplifiers, McIntosh found an effective way to solve these problems. We called it the Unity Coupled Circuit. The basic configuration is illustrated in the diagram of Fig. 3.

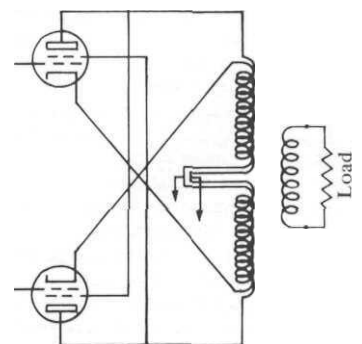

Fig. 3 — McIntosh "notch free" low distortion Unity Coupled Circuit

*Vice President of Research and Development, McIntosh Laboratory Inc.

The impedance ratio required between primary and secondary has been reduced by a factor of four-to-one compared with the conventional arrangement. It is now 125 to 1 (1000/8). The turns ratio is therefore only half of what it was before. Leakage inductance is therefore much lower, and so is the shunt capacitance across the windings. The use of a bifilar winding technique completely eliminates the leakage inductance problem of coupling between the sections of the primary windings. It was the development of the Unity Coupled Circuit by McIntosh (the circuit is patented) way back in 1947 that enabled us to produce amplifiers which were a whole order of magnitude lower in distortion than the competition of those days. Typically, we were able to produce power output circuits with total harmonic distortion of under 1.0% even before the distortion-reducing negative feedback loop was added. With just 20 dB of feedback applied, the THD was further reduced to under 0.1%!

What About Transistor Amplifiers

The audio industry welcomed the power output transistor as the solution to all its problems. After a few faltering starts (early germanium power output transistors were notoriously unreliable and easily destroyed by high operating temperatures), silicon power transistors became the standard power device in power amplifiers.

Since power output transistors exhibit a low output impedance, it was possible to design output circuits to match 8-ohm loads directly—without the need for a matching audio output transformer. Indeed, most OTL amplifiers, when coupled to 8-ohm resistive loads for test purposes, can deliver full rated power to those loads for long periods of time without overheating or exceeding safe thermal dissipation limits. The trouble is that we don't listen to resistors we listen to loudspeakers. It will come as no surprise to you to learn that speakers having a "nominal" impedance of 8 ohms often measure lower and higher impedance values at different audio frequencies. Then, too, consider the fact that many popular speaker systems have nominal impedances of 4 ohms, and the impedance of 4 ohm speakers can easily dip down to as low as 2 ohms at certain

frequencies. What happens to an OTL amplifier with such low impedances connected to it? In theory, if an output stage is designed to match an 8 ohm impedance, its power "output capability should double when it's connected to a 4 ohm impedance. But as this mismatch occurs, thermal dissipation increases rapidly. In fact, operating into a 4 ohm load, heat dissipation is double what it would be when operating at 8 ohms, as illustrated in Fig. 4. Unfortunately, if the amplifier was designed for 8-ohm operation, its thermal dissipation limits were designed with some safety factor

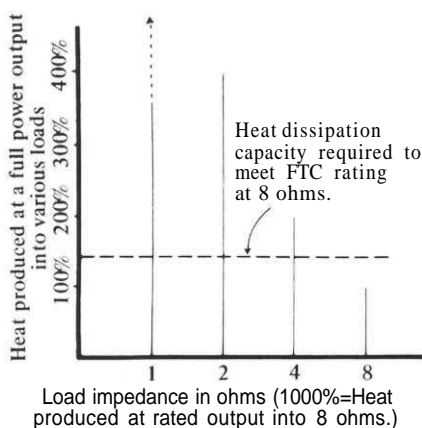

Fig. 4 - Heat produced by transformerless amplifier at various load impedance

for 8 ohm operation, so as to meet the new FTC preconditioning requirements. These call for the amplifier to be able to deliver one-third rated power at rated impedance for one hour. But, as you can see from Fig. 4, the safety margin is not nearly great enough to permit operation at 4-ohms—or 2-ohms-or 1-ohm impedances. Remember, too, that many amplifiers and receivers have provisions for connection of more than one pair of speakers for use in different listening rooms, so that even if 8-ohm speakers are selected, using double pairs of them results in a 4-ohm net nominal impedance even before allowing for downward variations in impedance at specific frequencies in the audio spectrum. So, unless manufacturers are willing to resort to disproportionately massive heat sinks, cooling fans or combinations of both, designing power amplifiers that can deliver their maximum powers at both 8 ohms and im-

pedances of 4 ohms and lower becomes physically impractical in the case of the OTL amplifiers.

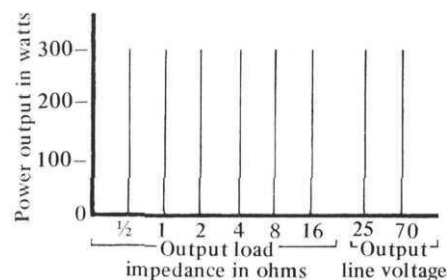

Fig. 6 - Performance of MC 2300

The Answer-Output Transformers!

If a transistorized amplifier were equipped with an output transformer, you could move up or down in load impedance and maintain full power ratings without over-dissipating anything, since the amplifier's output stages would always be working into an ideal load.

To many hi-fi enthusiasts, output transformers tend to create visions of compromised design. That is just not the case today. Technology in materials and transformer design methods have advanced significantly in recent years and, remember, we're dealing with low impedance devices—not tubes.

It's no longer necessary to translate impedances from a "plate circuit" to a speaker—a step down of several hun-

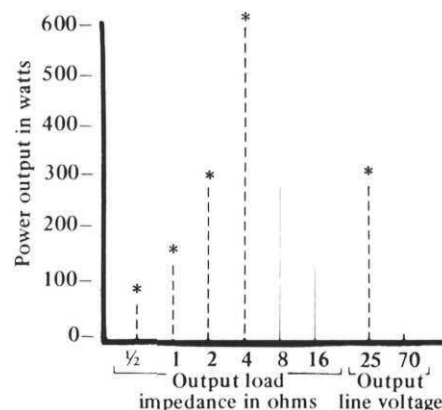

(* - - - Continuous operation not possible due to overheating. Protection circuit is assumed to current limit when load falls below 4 ohms and lower impedances will fall below the values shown.)

Fig. 7 - Performance of non McIntosh transformerless amplifier rated for 300 watts in 8 ohm load

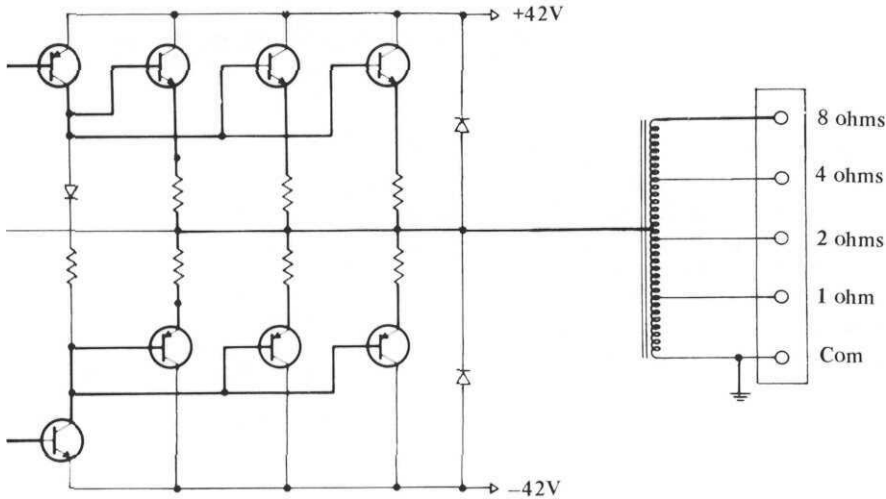

Fig. 5 - McIntosh MC 2205 output stage and transformer

dred to one. With transistor output stages, a ratio of only about 4 to 1 is required. In tube amplifiers, extremely good balance in the push-pull primary was required if notch distortion was to be avoided. Now, using a single ended push-pull transistor output stage the transformer can be driven in a single ended fashion. One end of the winding is returned to ground potential. With the transformer at ground, no isolation is required between the input and output and therefore a simple auto-transformer can be used.

Fig. 5 shows a typical arrangement used in our new MC 2205 amplifier. The output stages are designed to work optimally into a load impedance of 2.1 ohms and it becomes a simple matter to "tap into" the auto-transformer for that precise impedance match. Taps for 1 ohm, 2 ohm, 4 ohm and 8 ohm operation are arranged so that the output transistors continue to work into their optimum impedance. The result: full power output at any of these impedances, with no possibility of thermal over-dissipation.

Our popular MC 2300 amplifier also uses an auto-transformer and Fig. 6 shows how that amplifier is able to deliver its full rated power (300 watts RMS per channel) into any impedance from 0.5 ohms to 16 ohms, as well as to 25 volt and 70 volt multi-speaker system taps on the transformer. If we compare these results with those obtained with a similarly rated

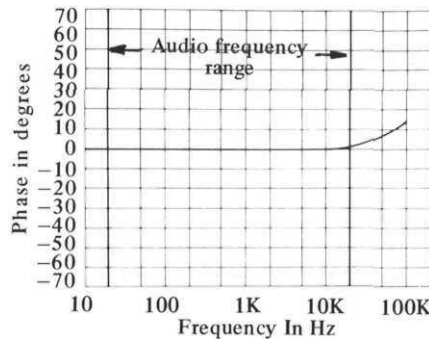

Fig. 8A - Typical of phase shift in McIntosh auto-transformer at 8 ohms

OTL amplifier (Fig. 7) we see that at all but 8 and 16 ohms, continuous operation at theoretical maximum power is impossible because of overheating and protection circuit limiting. Operation at 16 ohms, though possible, is limited to a maximum power output of 150 watts, in this case, while operation into a 70-volt line is impossible because of limitations in power supply voltages.

What About Phase Shift?

Critics opposed to the use of transformers in output circuits of audio amplifiers are quick to point out that "transformers introduce phase shift" at the low and high frequency extremes. As a matter of fact, a properly designed transformer (and we'll get into some of the factors that are involved in designing McIntosh output

transformers in a moment) can introduce about 3 degrees of phase shift at 20 kHz (Fig. 8A), which is certainly insignificant. The typical volume control used on amplifiers (both those that are OTL and those equipped with transformers) introduce more shift than that—about 20 degrees in fact (Fig. 8B). Since an output transformer is driven from an extremely low impedance, there is actually more low-frequency phase shift caused by the usual input coupling capacitor at these low frequencies than by the transformer.

So, why haven't more manufacturers used output transformers on solid-state amplifiers? Possibly they are not aware of the technology, but more likely they don't want to spend the extra cost. A good transformer is an expensive component. It is heavy, takes up a fair amount of space and contradicts the audiophile's notion that transistorized equipment must be small and lightweight. Be that as it may, the FTC regulations suggest that output transformers are the only logical solution to rating audio amplifiers honestly at 4, 8, 16 or any other impedance required.

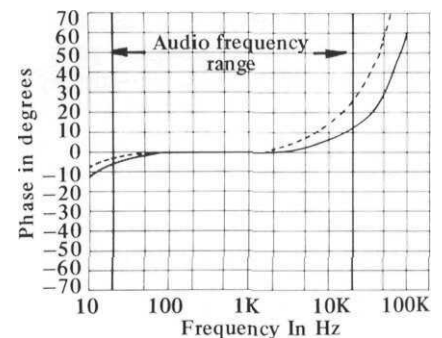

1 watt, 8 ohms
— Volume Control Clockwise
- - Volume Control 12 o'clock

Fig. 8B - Typical phase shift in a complete McIntosh amplifier

Not Just Any Transformer!

At McIntosh, we wind all our own output auto-transformers. Of course, we could purchase them from any one of a number of transformer companies who do nothing but wind transformers (our power transformers are, in fact, purchased from other suppliers), but we have long since found that transformers can't always be made successfully "according to the book". A great deal of experimentation is required before a new design of a transformer can

be mated to a specific amplifier circuit. We went through dozens of developmental samples in the case of our new MC 2205 amplifier. What we ended up with is shown schematically in the diagram of Fig. 9. The transformer is trifilar wound to provide coupling between sections. It takes 23 individual windings to make this output transformer. There are five different winding sections, all five of which are connected in parallel. We use grain oriented silicon steel core laminations because that kind of core means less iron-and less iron in turn means tighter coupling. It also means lower winding resistance for a given size wire. The grain oriented silicon steel means that it has a higher magnetic saturation point-about 17 kilogauss versus 12 to 13 kilogausses for the non-oriented variety. There is therefore less core loss, or, to put it simply, we end up with a more efficient transformer-one which couples more of the available amplifier power to the speaker loads. To further improve coupling, we don't use any interlayer insulating paper in a power transformer that might pose a breakdown problem. But since our polyurethane insulated

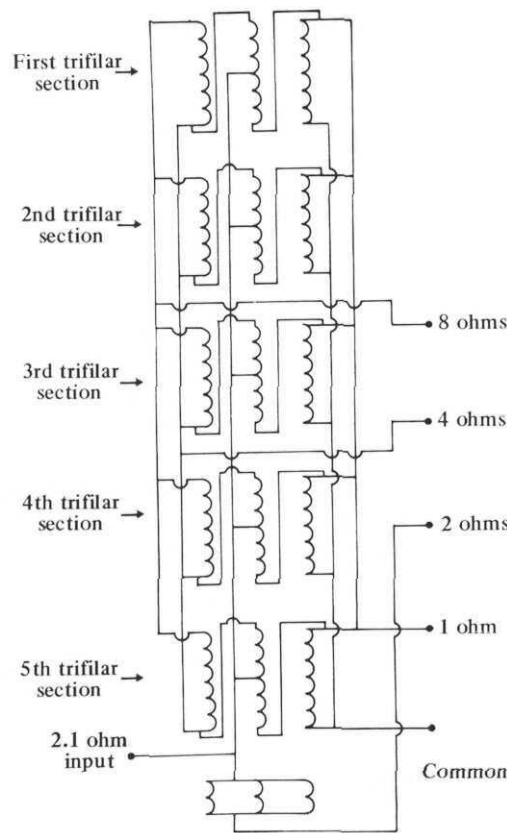

Fig. 9 - MC 2205 output auto-transformer schematic diagram

wire is rated at 4000 volts per mil (and since the highest voltage we're talking about for an audio transformer is about 56 volts), this really is no problem at all. All of our output transformers are potted with material which has especially high thermal conductivity. Besides helping to keep operating temperatures within the transformer down, this compound reduces lamination buzz to inaudible levels. We figure you'd rather listen to your speakers than to our transformers!

Our Transformers Are Only Part of The Story

Whether an amplifier uses an output transformer or not, its output devices must be designed to work into an optimum load so that maximum current delivered by the output transistors never exceeds the safe operating area specified for the transistor. Fig. 11 shows current versus voltage limitations for the epibase type of output transistor used in our MC 2205 amplifier. If all amplifier loads were purely resistive, staying within the safe operating area would be relatively simple, but the fact is that speakers often pre-

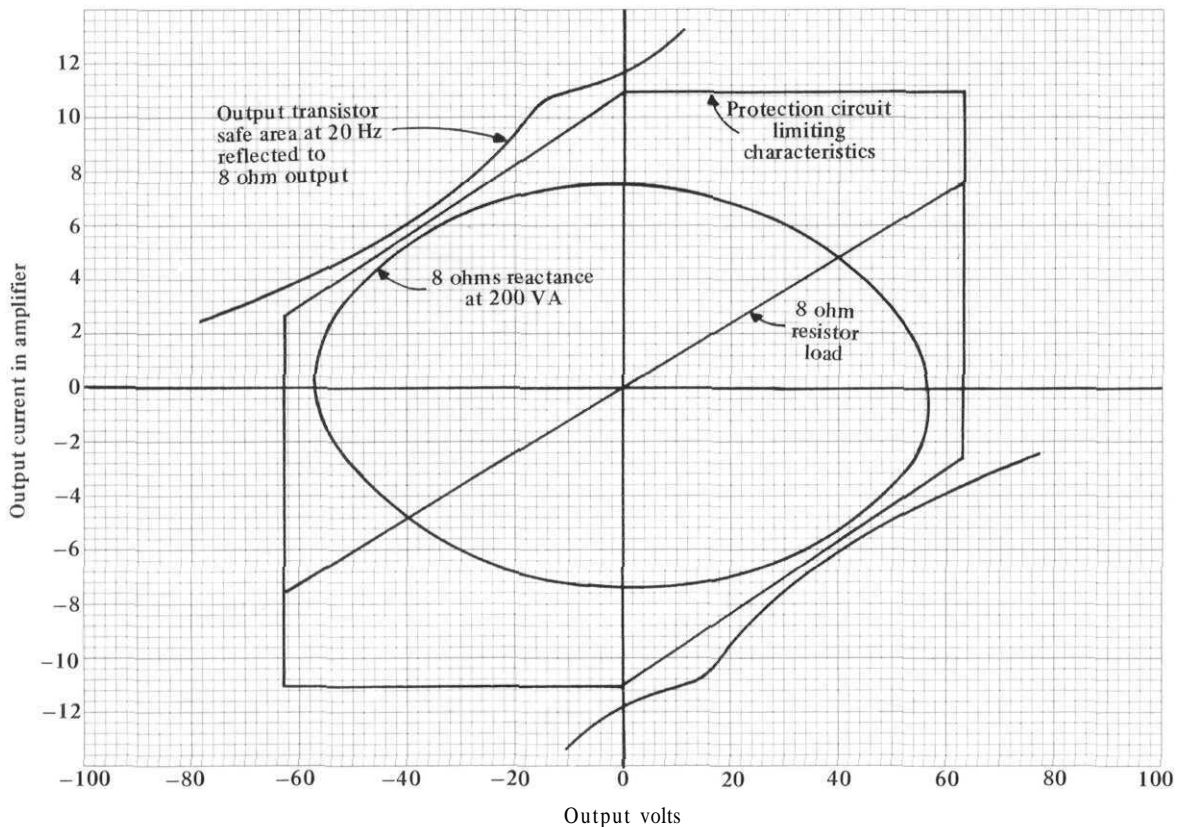

Fig. 10-Load and limiting data of the McIntosh MC 2205 measured at 8 ohm output

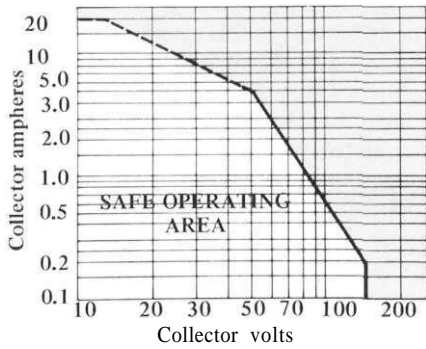

Fig. 11 - Current versus voltage limitation epibase type output transistor

fiers. In Fig. 10 we have combined the safe operating diagram of Fig. 10 with load and limiting characteristics at the 8-ohm tap of our MC 2205. As you can see, even when the load is totally reactive, every possible voltage and current condition falls within the safe operating area of the output devices used. Compare this diagram with Fig. 12 derived from data concerning the output transistors used in a currently available high-powered amplifier. Note that inadequate protection is

provided for reactive loads.

To Sum It All Up

The points we've tried to make are relatively few, but they spell the difference between a McIntosh output-transformer equipped amplifier and every other kind of amplifier around.

1. A transformer equipped amplifier will deliver rated power at any impedance for which a transformer tap is provided.

2. An OTL amplifier designed for 8-ohm operation cannot operate safely (according to the FTC rules) when driving lower impedances (4 ohms, 2 ohms, etc.), yet such loads commonly occur either because of speaker impedance variations with frequency or because of paralleling of multiple speaker systems across one channel of an amplifier.

3. The new FTC power rule regarding audio amplifiers has forced many manufacturers to omit 4-ohm ratings - even though 4-ohm speakers are in common use. McIntosh transformer-equipped audio amplifiers deliver full power at any impedance for which a transformer output tap is provided.

4. Because of their design, McIntosh

transformers introduce less series leakage inductance than is commonly encountered with OTL amplifiers which require a series inductance between the output circuit and the speaker connection for amplifier stability. At the 8 ohm tap of our MC 2205, leakage inductance is a low 3.5 microhenries. This represents an impedance of only 2.2 ohms at a frequency of 100 kHz.

5. Properly designed output transformers impose no limitations on frequency response. At the 8-ohm tap of the MC 2205, response is down 0.3 dB at 50 kHz. With a 4-ohm load connected, response is down 0.1 dB at 50 kHz.

6. Phase response of the MC 2205 amplifier, using its specially designed output transformer, is accurate to within 9 degrees at the 8 ohm tap at a frequency of 50 kHz and undergoes zero degrees of phase shift at 20 Hz. At the 4-ohm tap, phase shift at 50 kHz is only 7.2 degrees.

Next time anyone gets into an argument with you concerning the attributes of an OTL amplifier versus a McIntosh transformer-equipped amplifier, you might let your adversary read this story.

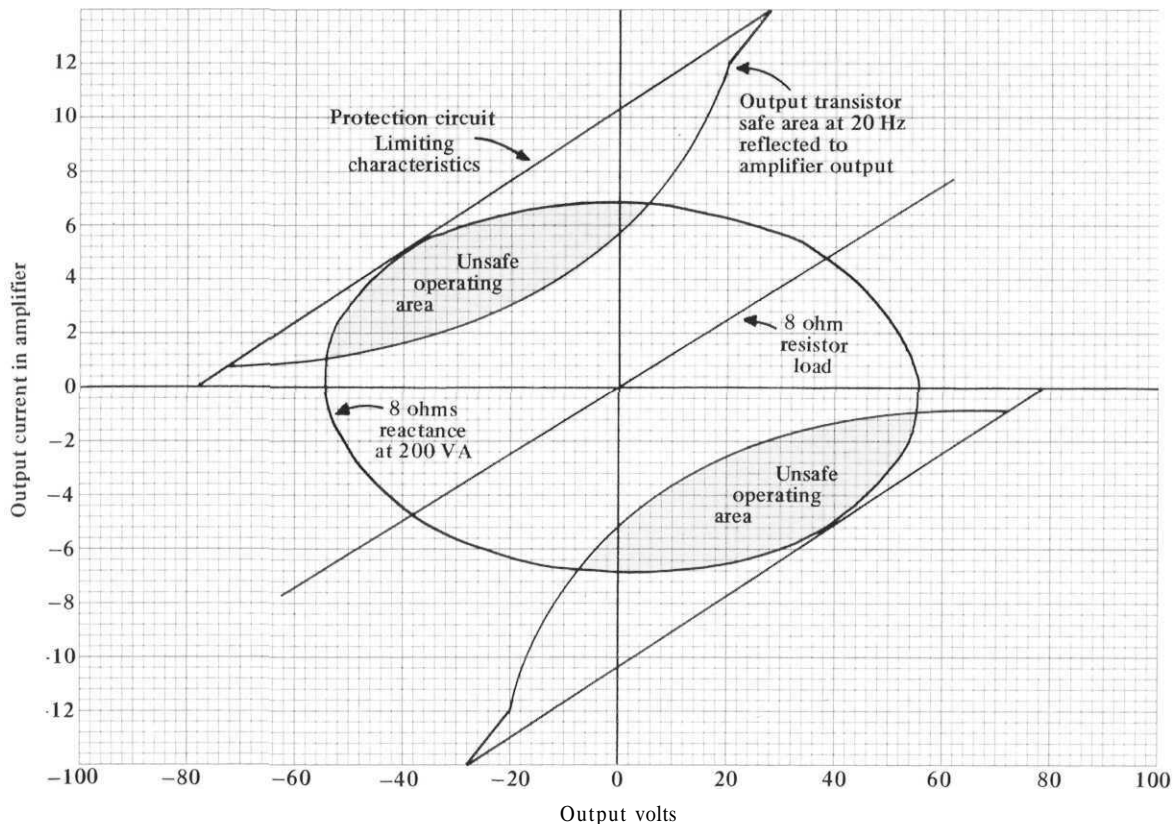
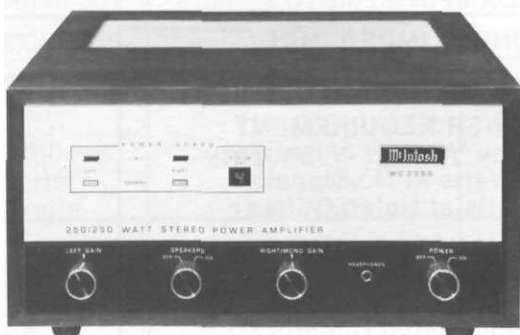

Fig. 12 — Load and limiting data of a non McIntosh high-powered transformerless amplifier measured at 8 ohms output.

You are *McIntosh* protected six ways with the new McIntosh amplifiers.



PROTECTION

1. The patented McIntosh Sentry Monitoring circuit constantly monitors the output signal. At signal levels up to rated output this circuit has high impedance and has no effect upon the output. If the power output exceeds design maximum, the Sentry Monitoring circuit operates to limit the signal to the output transistors. In the event of a short circuit across the amplifier output or severe impedance mismatch the Sentry Monitoring circuit will protect the output transistors from failure. Both positive and negative halves of the output signal are monitored independently.

PROTECTION

2. Should the temperature of the heat sinks rise above normal through restricted ventilation or other causes, the AC Power is disconnected by an automatic heat sensing relay. The AC power will be restored when the temperature returns to normal.

PROTECTION

3. Any loudspeaker damaging DC component in the output circuit, from whatever cause, is shunted to ground through the McIntosh autotransformer. You and your speakers are protected completely from this kind of amplifier failure.

PROTECTION

4. McIntosh gives you a money back guarantee of performance. Your McIntosh instrument must be capable of meeting its published performance limits or you get your money back. No other manufacturer offers you this money back guarantee of performance.

PROTECTION

5. The McIntosh 3 Year Service Contract protects you from the cost of repair for three full years because McIntosh will provide the service materials and labor needed to return the measured performance to the original performance limits. The SERVICE CONTRACT does not cover any shipping costs to and from the authorized service agency or the factory.

PROTECTION

6. The Automatic Test System provides positive protection and extends the long trouble free life of an amplifier. Each time the amplifier is turned on seven tests measure and verify accurate performance. Automatic Test System protects by verifying circuit readiness before operation starts. Each time a test is verified a numeric indicator turns on to indicate the test being performed. If in the test countdown an unacceptable voltage is encountered, the numeric designation locks to isolate the faulty circuit.

POWER AMPLI

MC 2500

POWER OUTPUT STEREO Minimum Watts, Both Channels Operating	500 Watts Per Channel
POWER OUTPUT MONO Minimum Watts	1000 Watts
POWER BAND WIDTH	20 Hz to 20 kHz
TOTAL HARMONIC DISTORTION Maximum, 250 mW to Rated Power, 20 Hz to 20 kHz	0.02%
OUTPUT LOAD IMPEDANCE Stereo Mono	1, 2, 4, 8 W 1/2, 1, 2, 4, 8, 16 W
INTERMODULATION DISTORTION Maximum, 250 mW to Rated Power	0.02%
FREQUENCY RESPONSE 20 Hz to 20 kHz (at 1 Watt)	+ 0. -0.25 dB
NOISE AND HUM Below Rated Output	-95 dB
OUTPUT VOLTAGES FOR DISTRIBUTION SYSTEMS	25 Volts
DAMPING FACTOR	greater than 30
INPUT IMPEDANCE	50.000W
INPUT SENSITIVITY	0.75 or 2.5 Volts
POWER REQUIREMENT AC Line Voltage - Frequency Watts at No Signal Watts at Rated Output	120V, 50-60 Hz 75 Watts 1800 Watts
SEMICONDUCTOR COMPLEMENT Transistors Diodes Integrated Circuits	91 35 6
SIZE Panel Height Panel Width Depth	10-1/2" (26.7cm) 19" (48.3cm) 17" (43.2cm)
FINISH	Gold and Black Panel, Black Knobs
WEIGHT Net In Carton	129#(58.5kg) 144#(65.3kg)
HEAT SINK AREA	1990 sq. in.
SPECIAL FEATURES Power Guard	
Output Autoformers	X
Automatic Test System	N/A
Output Meters: Calibrated in Watts	X
Output Meters: Calibrated in dB	X
ThermalTurn-Off	X
Sentry Monitor	X
D.C. Speaker Protection	X
Output Limit Indicator	X
Panloc Mounting	N/A
Cooling: Convection	N/A

McIntosh

PERFORMANCE GUARANTEED

Performance limits are the maximum deviation from perfection permitted for a McIntosh instrument. We promise you that when you purchase a new McIntosh product from a Franchised McIntosh dealer it will be capable of performance at or exceeding these limits or you can return the unit and get your money back. McIntosh is the only manufacturer that makes this statement.

McIntosh audio power ratings are stated in accordance with the Federal Trade Commission Regulation of November 4, 1974 concerning power output claims for amplifiers used in home entertainment products.

FIER PERFORMANCE LIMITS

MC 2255	MC 2250	MC 2155	MC 2120	MC 502
250 Watts Per Channel	250 Watts Per Channel	150 Watts Per Channel	120 Watts Per Channel	75 W/Chan. 2.7 to 4 W 50W/Chan. 8 W
500 Watts	500 Watts	300 Watts	240 Watts	150 Watts into 8 Ohms
20 Hz to 20 kHz	20 Hz to 20 kHz	20 Hz to 20 kHz	20 Hz to 20 kHz	20 Hz to 20 kHz
0.02%	0.02%	0.02%	0.1%	0.02%
1, 2, 4, 8 W 1/2, 1, 2, 4, 8, 16 W	1, 2, 4, 8 W 1/2, 1, 2, 4, 8, 16 W	1, 2, 4, 8 W 1/2, 1, 2, 4, 8, 16 W	2, 4, 8, 16 W 1, 2, 4, 8 W	2.7 to 8 W 8W
0.02%	0.02%	0.02%	0.1%	0.02%
+ 0, -0.25 dB	+ 0, -0.25 dB	+ 0, -0.25 dB	+ 0, -0.25 dB	+ 0, -0.25 dB
-95 dB	-95 dB	-95 dB	-95 dB	-95 dB
25 Volts	25 Volts	25 Volts	25 Volts	25 Volts (Stereo Only)
greater than 30	greater than 30	greater than 30	14 to 50	>50
50,000W	50,000W	50,000 Si	100,000W	75,000W
0.75 or 2.5 Volts	0.75 or 2.5 Volts	0.75 or 2.5 Volts	0.75 or 2.5 Volts	0.75 or 2.5 Volts
120V, 50-60 Hz 70 Watts 1440 Watts	120V, 50-60 Hz 84 Watts 1440 Watts	120V, 50-60 Hz 84 Watts 720 Watts	120V, 50-60 Hz 50 Watts 460 Watts	120, 50-60 Hz 20 Watts 400 Watts
85 47 14	76 37 9	81 47 14	39 24 2	39 20 4
7-1/8" (18.1cm) 16-3/16" (41.1cm) 14-1/2" (36.8cm)	6-31/32" (17.7cm) 16" (40.6cm) 14-1/2" (36.8cm)	5-7/16" (13.8cm) 16" (40.6cm) 14-1/2" (36.8cm)	5-7/32" (13.3cm) 16" (40.6cm) 14-1/2" (36.8cm)	3-5/8" (9.2cm) 16" (40.6cm) 14-1/2" (36.8cm)
Black Glass Panel, Gold/Teal Nomenclature, Gold and Black Knobs	Gold Panel Gold and Black Knobs	Black Glass Panel, Gold/Teal Nomenclature, Gold and Black Knobs	Gold Panel, Gold and Black Knobs	Black Glass Panel, Gold/Teal Nomenclature, Gold and Black Knobs
82# (37.2kg) 96# (43.5kg)	80# (36.3kg) 94# (42.6kg)	65# (29.5kg) 77# (35kg)	57# (26kg) 70# (32kg)	27# (12kg) 38# (17kg)
1080 sq. in.	1080 sq. in.	772 sq. in.	772 sq. in.	513 sq. in.
X	X	X	X	X
X	X	X	X	N/A
X	X	X	N/A	N/A
X	N/A	X	N/A	N/A
X	N/A	X	N/A	N/A
X	X	X	X	X
X	X	X	X	X
X	X	X	X	X
X	X	X	X	X
X	N/A	X	N/A	X
X	X	X	X	X

THE McINTOSH C 27

STEREO PREAMPLIFIER

STATE-OF-THE-ART PERFORMANCE WITH FLEXIBILITY



PERFORMANCE LIMITS and RATINGS

FREQUENCY RESPONSE:

+0, -0.5 dB 20 Hz to 20,000 Hz.

DISTORTION:

Will not exceed 0.05% at rated output level, 20 Hz to 20,000 Hz.

INPUT SENSITIVITY AND IMPEDANCE:

Auxiliary 1 and 2, Tuner, Tape 1 and 2: 250 millivolts at 100,000 ohms. Phono 1 and 2: 2 millivolts at 47,000 ohms and 100 pF.

HUM AND NOISE:

Auxiliary 1 and 2, Tuner, Tape 1 and 2: IHFA 90 dB; unweighted 85 dB below rated output. Phono 1 and 2 IHFA 85 dB; unweighted 80 dB below 10 millivolts input.

OUTPUT LEVEL:

Main Output: 2.5 volts with rated input. Maximum output is greater than 10 volts. Tape Output: 0.25 volts with rated input. Maximum output is greater than 10 volts. Center Channel Output: (L + R) 2.5 volts with rated input.

SEMICONDUCTOR COMPLEMENT:

18 silicon-planar transistors, 4 silicon diodes, 5 light emitting diodes.

AC POWER OUTLETS:

1 unswitched (red), 4 switched (black).

POWER REQUIREMENT:

120 volts, 50/60 Hz, 15 watts.

FACILITIES AND FEATURES

BASS:

Separate 11 position rotary switches for each channel. -17 dB to +16 dB at 20 Hz.

TREBLE:

Separate 11 position rotary switches for each channel -20 dB to +20 dB at 20kHz.

LOUDNESS:

Flat response, or continuously variable loudness equalization as volume level is reduced.

BALANCE:

Natural balance at center position, attenuation of left or right channel by rotating control.

VOLUME:

Precision step attenuator for precision tracking at all listening levels. Does not change stereo balance as volume is changed.

INPUT:

5 positions—Auxiliary 1 and 2, Tuner, Phono 1 and 2.

MODE:

7 positions—Left channel only to both speakers. Right channel only to both speakers, Stereo Reverse, Stereo, Mono (L + R), L + R to Left speaker only, and L + R to Right speaker only.

TAPE MONITOR:

Two pushbutton switches. Either of two tape recorders may be monitored.

TAPE COPY SWITCH:

Two pushbutton switches. Either of two tape recorders may be connected to copy from one to the other in either direction.

LF FILTER (Rumble Filter):

Flat or roll-off 6 dB per octave below 50 Hz, down 12 dB at 20 Hz.

HF FILTER (Scratch Filter):

Flat or roll-off 6 dB per octave above 5kHz, down 12 dB at 20k Hz.

C 504 is a compact state-of-the-art preamplifier.



PERFORMANCE LIMITS and RATINGS

C 504 is the same as the preamplifier section of the MX 117 found on page 38.

MECHANICAL INFORMATION

SIZE:

Front panel measures 16 inches wide (40.6 cm) by 3 5/8 inches high (9.2 cm). Chassis measures 14 3/4 inches wide (37.5 cm) by 2 3/8 inches high (6.0 cm) by 14 1/2 inches deep (36.8 cm), including connectors. Knob clearance required is 1 1/4 inches (3.2 cm) in front of mounting panel.

FINISH:

Front panel is anodized gold and black with special gold/teal nomenclature illumination. Chassis is black.

MOUNTING:

McIntosh developed professional PANLOC.

WEIGHT:

14 pounds (6.4 kg) net, 25 pounds (11. kg) in shipping carton.

PRODUCT ANALYSIS

THE McINTOSH C 27 STEREO PREAMPLIFIER



Fig.1 - Front view

MANUFACTURER'S PUBLISHED PERFORMANCE LIMITS (SPECIFICATIONS):

Rated Outputs: Main, 2.5 volts (Maximum greater than 10 volts) into 22k ohm load or greater; Tape, 0.25 volts (Maximum greater than 1.0 volts) into 22k ohm load or greater; Center Channel (L+R), 2.5 volts into 22k ohm load or greater. Input Sensitivities: High Level, 250 millivolts at 100k ohms; Low Level (Phono 1 & 2), 2 millivolts at 47k ohms and 100 pF. Frequency Response: (any input): 20 Hz to 20 kHz, +0, -0.5 dB. Hum and Noise: (Phono): 80 dB below 1.0 mV input, unweighted, 85 dB IHF "A" weighted; (High Level): 85 dB unweighted; 90 dB IHF "A" weighted.

GENERAL SPECIFICATIONS:

Dimensions: Front Panel: 16" W x 5-7/16" H. Chassis: 15" W x 5" H x 13" D including PANLOC shelf and back panel connectors. Required knob clearance in front of mounting panel: 1 1/2". Net Weight: 20 lbs. Power Requirements: 120 V, 50/60 Hz.

Serious devotees of the audio art may be somewhat surprised to find that McIntosh Laboratory Inc. has introduced yet another top performing preamplifier/control unit, less than one year after the introduction of their all-out C 32 preamplifier. In previous times, McIntosh was never noted as a company that subscribed to the annual cosmetic "model changes" so often seen from other high fidelity component

manufacturers. Well, for all those thousands of dedicated Mac fans let us preface this report by stating emphatically that the newly designed C 27 is much more than a cosmetic face-lift of older models. In fact, the highly acclaimed "McIntosh look" of the front panel has been retained, while new internal circuitry, from stem to stern, makes this new entry a state-of-the-art design that should enjoy the same sort of longevity typical of other McIntosh products. The earlier-introduced C 32 was, as we said, a multiple featured product, with such built-in accessory features as a full five-control graphic equalizer and an adjustable linear expander, not to mention its fully separate monitoring/headphone amplifier output facilities.

The C 27 takes a more restrained approach in which those features that are deemed important to most pre-amplifier/control users are retained but other accessory facilities are omitted in favor of a suggested retail price that will be affordable to a greater number of potential purchasers. Think of the C 27 as a "middle of the road" unit in terms of its control facilities and flexibility. It is not a unit that subscribes to the "straight wire with gain" approach - an approach which we, at least, have always felt is a bit unrealistic. After all, how many of us are blessed with companion components, speakers, or even room acoustics that require absolutely no control "tweaking"? Rather than do away with such control features as tone controls or filters, it seems to us that it is far more useful for the consumer to have these facilities providing that their presence in the signal path does not introduce any form of distortion. Evidently McIntosh felt the same way and, as we learned during our lab testing of the C 27, these features, when deactivated or, in the case of the tone controls, when placed in their nominal flat positions, do not in any way negate the "straight wire with gain" concept which some purists espouse.

The front panel of the C 27, pictured in Fig. 1, is anodized gold and black with McIntosh's familiar gold-teal panel nomenclature illumination which magically appears when power is applied. Rotary controls along the top of the panel include a five-position program input selector (aux 1, aux 2, tuner, phono 1 and phono 2), a mode selector (left or right to both outputs, stereo reverse, stereo, L+R mono, left plus right to left or right outputs) and, at the extreme right, the master volume control. The four rotary control sets at the lower right of the panel are dual concentric types. The first of these introduces, singly or in combination, the high and low cut filters and selects either or both sets of loudspeakers which can be switched via the front panel providing that the power amplifier's outputs are connected to the rear of the C 27 instead of directly to the speakers. Bass and treble tone controls permit tonal tailoring of each channel separately while the right-most control in this group is a combination balance and loudness control. The loudness control of the C 27

works a bit differently from that contained in the C 32. The user is instructed to set the volume control for maximum (lifelike) listening levels while the loudness knob is set to its "flat" (counterclockwise) position. Then, for lower listening levels, the loudness control is rotated (rather than the volume control) and proper Fletcher-Munson compensation is introduced as listening levels are lowered.

Completing the panel layout is a group of push-buttons and a headphone jack at the lower left. The buttons, five in all, take care of the two tape monitor circuits and provide tape dubbing from either of two connected tape decks to the other.

The final button turns on power to the unit and has an illuminated rectangle just above it to indicate that power is on.



Fig. 2 - View of back panel

The rear panel of the C 27 is shown in Fig. 2. Adjacent to the four switched and one unswitched convenience AC receptacles are three sets of spring-loaded terminals which require only that the stripped ends of power amplifier and speaker connecting cables be inserted in small holes that are exposed when the terminal keys are depressed. It is this arrangement which brings speaker switching capability to the front panel of the C 27, and a handy feature it is, too, since most high quality basic power amplifiers are normally equipped with only one set of speaker terminals. The right portion of the rear panel is equipped with the necessary phono-tip jacks for signal inputs, tape in and tape out circuits, two pairs of main output jacks (in case you want to feed two separate power amplifiers) and a "center channel" output for feeding the sum (L+R) of both channels to a separate monophonic power amplifier for background music in an alternate location or for powering a center-channel speaker system in the main listening area. A 0.5 ampere line fuse holder completes the rear panel layout.

Circuit Highlights

Internally, the C 27 major circuit board contains all of the audio signal handling active circuitry, including the preamplifier-equalizer low level stages. Smaller p.c. modules include the pushbutton switch circuits, input

terminal boards, a switch indicator circuit board (for illuminating the front panel LED's that light up when tape monitoring or tape copying is employed) and a power supply module. Signal paths can be traced by consulting the block diagram of Fig. 3. The input selector routes the different input signals within the C 27. Isolating networks are present at each high level input and shorting switch contacts ground unused inputs. The isolating networks also block any DC voltages that might be present, preventing pops or clicks when changing inputs. The phono preamp section uses three selected transistors per channel. Low impedance components are used in the RIAA equalization network, drive for which is provided by the final stage which operates at an adequate current level to drive the low impedance without slew rate limiting. Isolating networks are included at each tape output and input, The volume control is a step attenuator type having 32 steps and 70 dB of range plus a total attenuation position. A voltage gain stage follows the volume control and provides 14 dB of gain. High and low cut filters follow, with the signals then passed along to the loudness and balance control and thence to another gain stage for an additional 6 dB of amplification. This last gain section is used for the bass and treble control circuits and consists of a three-stage linear amplifier with tone controls included in a negative feedback circuit using precision capacitors and resistors for shaping the desired frequency response characteristics depending upon the setting of the tone controls. The output of this amplifier is fed to the two pairs of main output jacks.

The C 27 power transformer uses a grain oriented silicon steel core plus copper and magnetic steel shields to eliminate radiated magnetic hum fields. The power supply uses zener diode reference voltage regulation and electronic filtering. Turn-on and turn-off time characteristics of the power supply are controlled to prevent switching transients. Total semiconductor complement of the C 27 includes 18 silicon planar transistors, 4 silicon diodes and five light emitting diodes.

Laboratory Test Measurements

All of our measurements were made with respect to rated output (2.0 volts from the main output terminals) unless otherwise stated. We first studied the performance of the phono-equalizer section. Input sensitivity for rated output measured 2.3 millivolts for both phono inputs. Though McIntosh does not provide a "limit spec" for phono overload, we consider this to be an important specification. The phono inputs were able to handle signal levels of 1.35 millivolts at 1 kHz before noticeable first-stage distortion occurred — considerably more than is likely to be delivered even by a high output cartridge tracing the most heavily modulated record grooves. Signal to noise in phono, referred to a 10 mV input measured 82 dB unweighted, increasing to 89 dB when an "A" weighting network was inserted in the patch between the output and the measuring instruments. A word is called for regarding the play-

back curve measured via the phono inputs and shown as photographed from the face of our spectrum analyzer's CRT tube. McIntosh has wisely elected to adopt the new IEC standards for playback which call for an additional roll-off time constant of 7960 microseconds in addition to the three time constants normally prescribed for R1AA equalization. This final low-end roll-off makes a great deal of sense, since it reduces needless amplification of turntable rumble components which serve no purpose other than to overload the bass power output capabilities of modern power amplifiers (especially those that have response down to "DC") and to cause speaker cones to fluctuate wildly sending the voice coils into non-linear regions of operation. The final low-end roll-off or turnaround of the new curve is clearly visible in our 'scope photo of Fig. 4 and, al-

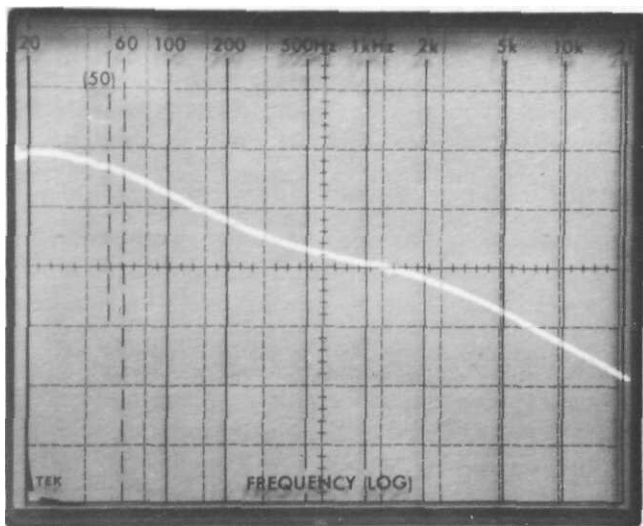

Fig. 4 - Playback response of phono preamp-equalizer section

though our frequency sweep extends only down to 20 Hz, the response continues to roll off below that frequency at a 6 dB per octave rate, exactly as prescribed by the new IEC standards. If you try to measure the phono response against the "old" RIAA curve, however, you will find that at 30 Hz it differs from the old prescribed **point-by-point** plot by approximately 1.3 dB. In terms of the new and preferred playback curve, the equalization of the C 27 was so accurate that it varied by no more than 0.1 dB at any of the remaining test points measured.

Fig. 5 is a plot of distortion versus frequency (at rated output) via the high-level inputs, as observed at the main output terminals. Over the entire spectrum from 20 Hz to 20 kHz, harmonic distortion never exceeded 0.025% and at mid frequencies it measured an extremely low 0.009%. Since the distortion measured from the phono inputs to the tape outputs was even lower, we did not bother to plot these results since the high-level section would govern actual distortion of the output signals under actual use condition. Though

McIntosh does not quote IM distortion figures for the C 27, we nevertheless measured this important parameter as well and, for rated equivalent output from the main output terminals obtained a reading of just

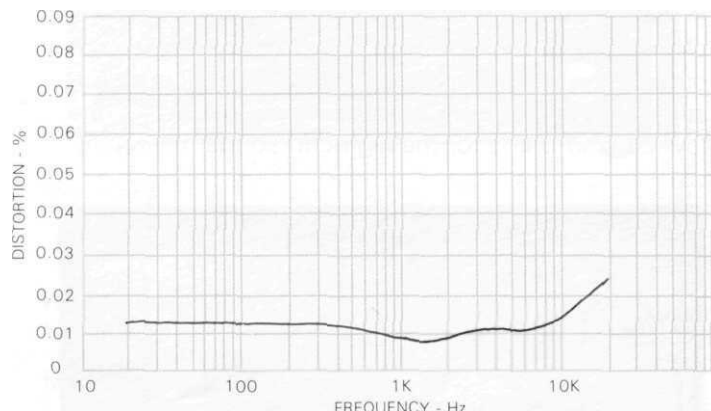

Fig. 5 - Distortion versus frequency, for rated output (2.0 volts) aux input to main outputs

under 0.04%. Maximum output obtained from the main output terminals was 100 volts for a rated distortion figure of 0.05% harmonic.

Tone control action of both the bass and treble controls is so precise and well calibrated that we decided to trace overall response for each of the ten possible settings of each of those controls. The results are displayed in the 'scope photo of Fig. 6. Flat response is re-

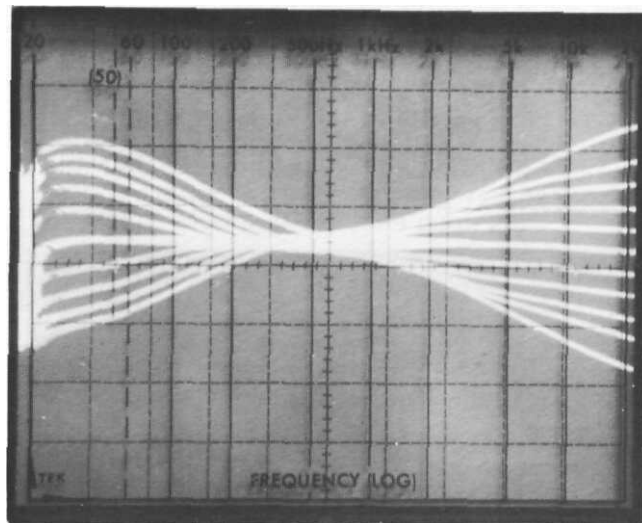

Fig. 6 - Step-by-step tone control response characteristics

presented by the center curve of this series and was measured as flat within 0.5 dB from 10 Hz to 23 kHz. The -3 dB points in response occurred at 4 Hz and 60 kHz. Signal to noise ratio in the high level settings measured 86 dB below rated output, unweighted, and

92 dB with an "A" weighting network inserted, both figures exceeding published limits of McIntosh. Volume control tracking was found to be accurate from left to right channels within 0.2 dB from maximum settings down to a -70 dB level

The action of the high and low cut filters is illustrated in the 'scope photos of Fig 7. While the slope rates are clearly only 6 dB per octave (we prefer steeper slopes ourselves), McIntosh wisely set the cut-off points at sufficiently high and low frequencies (50 Hz for the low-cut and 5 kHz for the high-cut) so that their intro-

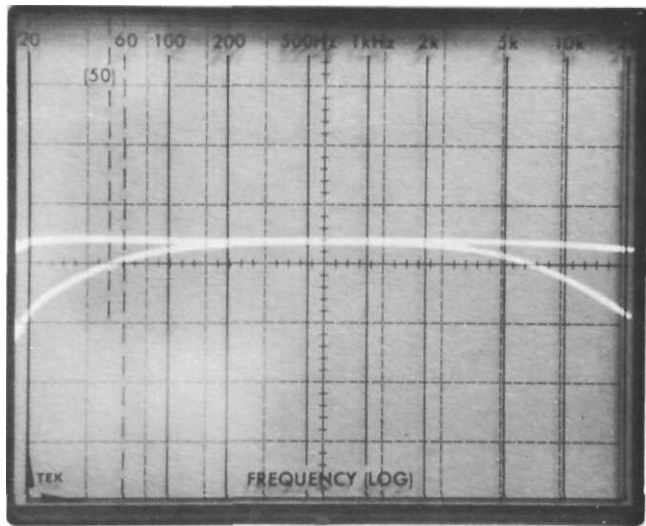

Fig. 7 - Low-cut and high-cut filter response

duction into the signal path would not take too big a "bite" out of musical content or program sources that require "cleaning up" because of background hiss or low frequency noise and rumble.

The action of the previously described loudness control is clearly illustrated in the three response plots

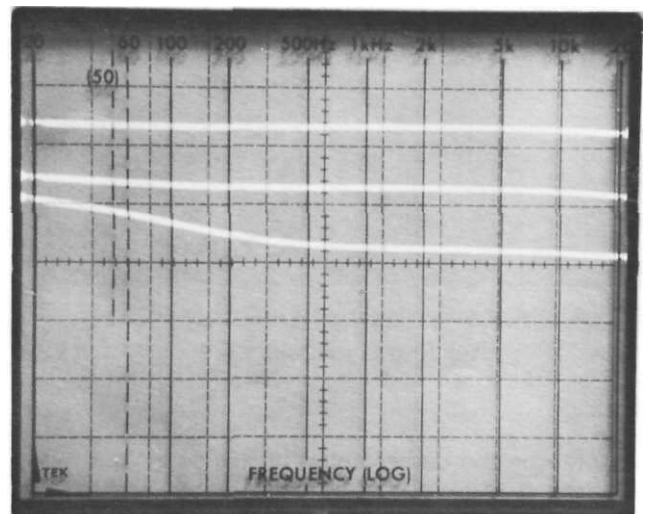

Fig. 8 - Action of separate loudness control at "flat" (upper trace), "mid" and "max" (lower trace) settings

shown in Fig. 8. Note that these curves were achieved with a constant setting of the master volume control and only the loudness control setting itself was varied, from one extreme to the other. Total level variation afforded by this control amounted to approximately 22 dB (each vertical division in this Figure as well as in Figs. 4, 6 and 7 represents an amplitude difference of 10dB).

Use and Listening Tests

As is true of other McIntosh components we have tested in the past, one immediately senses that the C 27 is, first and foremost, a reliably built product and one that is likely to last for a very long time and require a minimum of servicing. Controls have a positive and rugged feel about them and tend to be manipulated with confidence even by an inexperienced user encountering the product for the first time. We played a variety of discs through the phono section of the C 27, using our recently acquired Shure V15 Type IV cartridge for that purpose. Our record library now contains a good selection of direct-to-disc records which were reproduced flawlessly through the C 27 and a high quality 110-watt per channel power amplifier plus our reference loudspeakers. Transient response was superb and bass passages were tight and totally un-muddled. Attempting to use the phone jack we discovered that it must be powered from the interconnections of the associated power amplifier. In other words, the C 27, unlike the C 32, does not contain its own built-in headphone amplifier but rather derives phone power from the amp-speaker connections which are brought over to the unit for the switching capability incorporated in the C 27. A user of the C 27 would want to utilize this feature in any case, and there is an "off" position on the C 27's speaker switch for headphone-only listening once these connections are made-

All in all, McIntosh seems to have come up with a brand new preamplifier which should fit nicely into those systems which are comprised of the finest power amplifiers, speakers and program source components and whose owners either prefer to do without such extras as graphic equalizers or expanders or who would rather add such devices as separate accessories when and if the need arises. In our opinion, the suggested price of the new C 27 is not at all inconsistent with the level of performance achieved by the C 27 or with its excellent design, construction and control features.

McINTOSH c 29

SOLID STATE STEREO PREAMPLIFIER



PERFORMANCE LIMITS and RATINGS

FREQUENCY RESPONSE:

+0 -0.5 dB 20 Hz to 20,000 Hz.

DISTORTION:

.02% maximum at rated output level. 20 Hz to 20,000 Hz.

INPUT SENSITIVITY AND IMPEDANCE:

Auxiliary, Tuner, Tape 1, Tape 2, 0.25 volts at 250,000 ohms; Phono 1 and Phono 2, 2 millivolts (1,000 Hz) at 47,000 ohms and 65 pF; Microphone, 2.5 millivolts at 500,000 ohms.

HUM AND NOISE:

Auxiliary, Tuner, Tape 1, Tape 2, IHFA 100 dB; unweighted 90 dB below rated output. Phono 1, Phono 2 IHFA 90 dB; unweighted 80 dB below 10 millivolts input, equivalent to less than 1.0 microvolt at the input terminals. Microphone, 1.5 microvolts at the input terminals.

OUTPUT LEVEL:

Main Output: 2.5 volts with rated input, less than 100 ohms source impedance, to operate into 10,000 ohms or greater. Tape Output: 0.25 volts with rated input, less than 200 ohms source impedance, to operate into 10,000 ohms or greater. Headphone/Line: 0.75 volts into 8 ohm load or 2.5 volts into 600 ohm line. 47 ohms source impedance, level controls provided.

VOLTAGE AMPLIFICATION:

Phono 1, Phono 2 at 1 kHz to Main Output 62 dB, to Tape Output 42 dB, to Headphone/Line Output 72 dB. Auxiliary, Tuner, Tape 1 and Tape 2 to Main Output 20 dB, to Tape Output 0 dB, to Headphone/Line Output 30 dB. Microphone to Main Output 60 dB, to Tape Output 40 dB, to Headphone/Line Output 70 dB.

SEMICONDUCTOR COMPLEMENT:

9 Integrated Circuits, 2 Transistors, 11 Silicon Diodes, 8 Light Emitting Diodes (LED), 1 Silicon Controlled Rectifier (SCR), 1 Dual Light Dependent Resistor Network (LDR).

AC POWER OUTLETS:

2 automatic current sensing (green), 4 switched (black)

POWER REQUIREMENT:

120 volts, 50/60 Hz, 15 watts.

FACILITIES AND FEATURES

BASS:

Separate 11 position rotary switches for each channel, +20 dB to -20 dB at 20 Hz.

TREBLE:

Separate 11 position rotary switches for each channel. +18 dB to -18 dB at 20,000 Hz.

LOUDNESS:

Flat response, or continuously variable loudness equalization as volume level is reduced.

BALANCE:

Natural balance at center position, attenuation of left or right channel by rotating control.

VOLUME:

Precision step volume control with left to right tracking accuracy within 1 dB through its entire range.

INPUT:

Six positions—Auxiliary 1 and 2, Tuner, Phono 1 and 2, Microphone.

MODE:

Seven positions—Left channel only to both speakers. Right channel only to both speakers. Stereo Reverse, Stereo, Mono L + R to left speaker only, and L + R to right speaker only.

TAPE MONITOR:

Two pushbutton switches. Either of two tape recorders can be monitored by selecting the Tape 1 pushbutton or Tape 2 pushbutton.

TAPE COPY SWITCH:

Two pushbutton switches. Either of two tape recorders can be connected to copy from tape recorder 1 to tape recorder 2 or vice versa.

LF - HF FILTERS:

Reduce unwanted high frequency noise (above 7 kHz) and low frequency rumble etc. (below 50 Hz) at 12 dB per octave rate.

FRONT PANEL TAPE JACKS:

Allows connection to input and output of a tape recorder from the front panel.

HEADPHONE JACK:

For listening with either low or high impedance dynamic stereo headphones. Power to this jack is supplied by an amplifier in the C 29.

SPEAKER SWITCHES:

Turn Two sets of speakers on or off when properly interconnected with the accessory Speaker Control Relay. Model SCR-2 (see page 24).

MECHANICAL

SIZE:

Front panel measures 16 inches wide (40.6 cm) by 5-7/16 inches high (13.8 cm). Chassis measures 14-3/4 inches wide (37.5 cm) by 4-13/16 inches high (12.2 cm) by 13 inches deep (33.0 cm), including PANLOC shelf and back panel connectors. Knob clearance required is 1-1/4 inches (3.2 cm) in front of the mounting panel.

FINISH:

Front panel is anodized gold and black with special gold/teal nomenclature illumination.

CHASSIS:

Black

MOUNTING:

McIntosh developed professional PANLOC.

WEIGHT:

21 pounds (9.5 kg) net, 33 pounds (15 kg) in shipping carton.

IF YOU DESIGNED A PREAMPLIFIER THAT HAD THE FLEXIBILITY YOU WANT WITH THE PERFORMANCE YOU NEED IT WOULD LOOK LIKE THIS...



C 33 shown in optional walnut veneer cabinet.

Separate LISTEN and RECORD program circuits Record on up to 3 tape recorders from any connected source or copy from one tape recorder to another with complete independence from the program being listened to. The RECORD and LISTEN input selector switches operate without any interaction. The program being recorded can be monitored easily by pushing the monitor pushbutton.

Second generation electronic input switching Greater source to source isolation with much lower noise and distortion. Both LISTEN and RECORD input selectors control low DC voltages that electronically control Field Effect Analog switches. Because the FET analog switches are located at the input, noise, switch clicks and pops are eliminated and the potential from hum pickup is substantially reduced.

Five band tone shaping controls in either the RECORD or LISTEN circuits Five separate controls permit individual musical spectra shaping in two octave segments to satisfy personal preference or program limitations. There is 12 dB plus or minus control at center frequencies of 30, 150, 1,500 and 10,000 Hz. In the center (detent) position the tone shaping circuits are not

active. The overall frequency response of the C 33 is 10 Hz to 100 kHz.

- **PROGRAM COMPRESSOR** in either the RECORD or LISTEN circuits
Compression added to a tape recording permits expansion of playback for lower background noise and increased dynamic range. Compression can be added to either the RECORD or LISTEN circuit.
- **PROGRAM EXPANDER** is switched to either the RECORD or LISTEN circuits
Expansion added to playback of your tape recordings, phonograph records and broadcasts delivers increased dynamic range and lower background noise. Also permits the playback of specially encoded records.
- **Seven Inputs**
Complete facilities for 3 tape recorders, 2 turntables, 1 tuner and 1 other high level source.
- **Record Monitor**
Momentary action electronic switch allows tape outputs to be monitored and compared with the original program at the main outputs.

- **Signal Processor input and output for both LISTEN and RECORD circuits**
External signal processors can be connected to modify the program when recording or when listening.
- **Low Frequency and High Frequency Filters**
The low frequency (LF) filter attenuates the program material at 12 dB per octave below, 50 Hz to help eliminate rumble, acoustic feedback and other similar unwanted noises. Above 7,000 Hz the high frequency (HF) filter attenuates hiss, scratch and such unwanted noise at 12 dB per octave.
- **Active Loudness Control**
Loudness controls typically are simple, passive circuits connected to a portion of the rotation range of the volume control. As a consequence, loudness compensation accuracy is dependent on many variables such as speaker efficiency, amplifier gain and differences in input level. The C 33 loudness control is continuously variable, operates independently of the volume control, and its contour is accurately modeled after the Fletcher Munson family of "Equal Loudness" curves.
- **Front Panel Tape Jacks**
A fourth tape deck may be plugged into the front panel without disturbing your permanently wired system.
- **High Accuracy Tracking Volume Control**
The volume control is a step attenuator which has tracking accuracy within 1 dB throughout its entire range. Such extremely accurate matching is achieved through electronically controlled trimming of the resistance material deposited on pairs of printed circuits. Tracking accuracy and quiet performance are permanently maintained. Use does not affect performance as in ordinary volume controls.
- **Automatic Power Turn On/Turn Off**
Power to the entire stereo system can be controlled from either the front panel power switch or the turntable's power switch. A current sensing relay connected to the turntable AC power outlets is controlled by the turntable power switch. The relay, in turn controls the AC power to the remainder of the system. Sensitivity of the circuit is adjustable to match the current consumption of your turntable.
- **Two, new, quiet phono preamplifier circuits**
Two turntables can be used simultaneously, listen to one while recording from the other. New, third generation IC OP amps are used. Because they have lower noise and distortion than discrete devices, the C 33 is the quietest phono preamp ever.
- **Double shielded phono preamp**
Superior performance, even in the presence of strong interference fields, is assured by the use of the steel exterior chassis plus an inner shield enclosure of plated steel.
- **Triple Shielded Power Transformer**
A solid copper band, a silicon steel band and a mild steel outer casing confines the magnetic field of the power transformer to reduce the potential for hum pickup in either the C 33 or associated equipment. This expensive construction removes limitations on how or where you may install your equipment.
- **Electronically Regulated Power Supplies**
Maintains stable operation even during periods of low line voltage.
- **Power turn on/off Transient Protected**
Power turn on and off are electronically time controlled to prevent any thumps, pops or clicks.
- **Switched AC Outlets**
AC outlets for tape decks, tuners, etc. that turn ON and OFF with your preamp.
- **Auto Muting**
To prevent any annoying pops or clicks the main output is automatically muted when switching.
- **Program Output Switching**
Rear panel jacks are provided to connect two additional power amplifiers for feeding program material to remote areas. Front panel pushbuttons will turn the program on or off to the remote amplifiers. Alternately, the pushbuttons can control remote speaker systems when used with an accessory switching relay (the McIntosh SCR 2).
- **LED Function Indicators**
Long life solid state indicators show the system status.
- **Unique Flexible Mode Switch**
Can be used in seven modes of operation.
- **Monitor Amplifier**
A wide band, very low distortion 20 watts per channel power amplifier feeds the front panel Headphone jacks, the 600 ohm line outputs and monitor outputs. Complete protection is assured by the McIntosh developed and patented POWER GUARD and Sentry Monitor circuit. You can listen in private to headphones with the main power amplifier turned off, use the Monitor Output to feed remote loudspeakers or in association with audio time delay devices and other applications.
- **Full Monitor Amplifier Input Flexibility**
Input to the Monitor Amplifier can be selected from three inputs: the LISTEN circuit, the RECORD circuit, or the external input jacks on rear panel.
- **Dual Headphone Jacks**
Two pairs of headphones may be powered from the internal monitor amplifier.
- **Modular Construction**
Should service be required, it can be done quickly and easily.

**PERFORMANCE LIMITS and RATINGS
PREAMPLIFIER SECTION**

FREQUENCY RESPONSE

+ 0, -0.5dB from 20Hz to 20,000Hz

MAXIMUM VOLTAGE OUTPUT

10 volts from 20Hz to 20,000Hz

TOTAL HARMONIC DISTORTION

0.01% maximum from 20Hz to 20,000Hz
at rated output

SENSITIVITY

Phono- 2mV for 2.5V rated output
(0.4mV IHF)

High Level- 250mV for 2.5V rated output
(50mV IHF)

SIGNAL TO NOISE RATIO, A-WEIGHTED

Phono- 90dB below 10mV input
(84dB IHF)

High Level- 100dB below rated output
(86dB IHF)

MAXIMUM INPUT SIGNAL

Phono- 100mV
High Level- 10 volts

INPUT IMPEDANCE

Phono- 47k ohms and 65pf capacitance
High Level- 50k ohms

EQUALIZATION CONTROLS

Variable 12dB boost to 12dB cut at center frequencies of 30, 150, 500, 1500, 10k Hz

COMPANDOR RATIOS

From 1:2 compression to 2:1 expansion

LF FILTER

Flat or roll-off at 12dB per octave below 50 Hz.

HF FILTER

Flat or roll-off at 12dB per octave above 7,000 Hz.

MONITOR AMPLIFIER SECTION

CONTINUOUS AVERAGE POWER OUTPUT

20 watts per channel into 8 ohms, from 20Hz to 20kHz, at 0.01% maximum harmonic distortion

FREQUENCY RESPONSE

+ 0 -0.2dB from 20Hz to 20,000Hz

SENSITIVITY

750mV for rated output (170mV IHF), input impedance is 27K ohms

SIGNAL TO NOISE RATIO, A-WEIGHTED

100dB below rated output (87dB IHF)

GENERAL INFORMATION

SEMICONDUCTOR COMPLEMENT

31 Bipolar Transistors

76 Field Effect Transistors

35 Integrated Circuits

107 Diodes

1 Silicon Controlled Rectifier (SCR)

AC POWER OUTLETS

2 turntable current-sensing, 100 watts, green
4 switched, 1200 watts total, black

POWER REQUIREMENTS

120 volts, 50/60 Hz, 25 to 85 watts

MECHANICAL INFORMATION

SIZE:

Front panel measures 16 inches wide (40.6 cm) by 5-7/16 inches high (13.8 cm). Chassis measures 15 inches wide (38.1 cm) by 5 inches high (12.7cm) by 13 inches deep (33.0 cm), including PANLOC shelf and back panel connectors. Knob clearance required is 1-1/2 inches (3.81 cm) in front on the mounting panel.

WEIGHT:

26 pounds (11.8 kg) net, 38 pounds (17.2 kg) in shipping carton

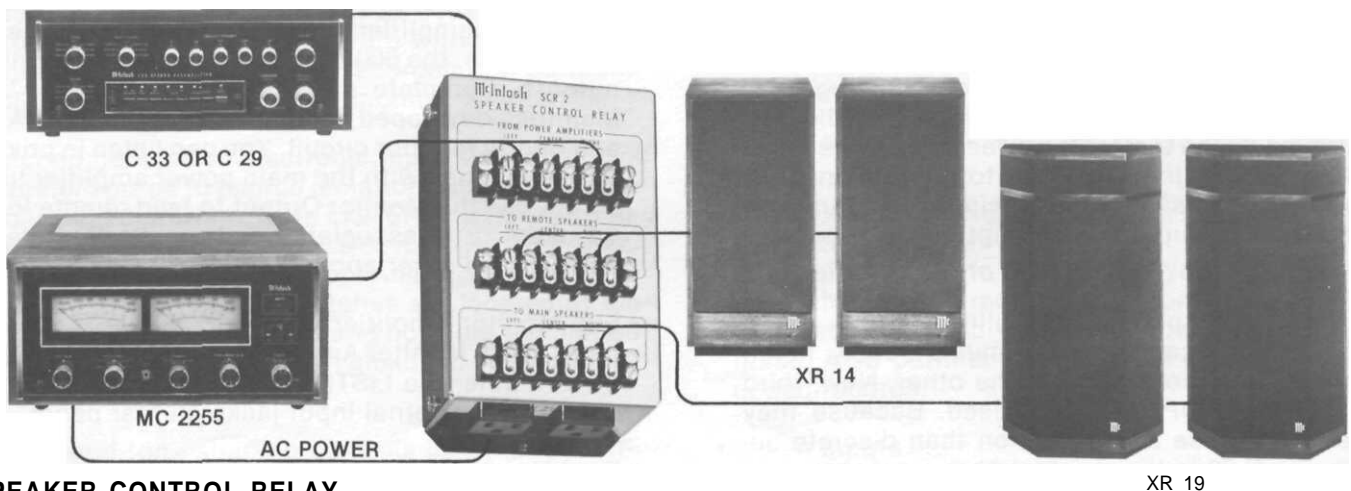

SPEAKER CONTROL RELAY

The McIntosh (SCR 2) Speaker Control relay is used with the McIntosh C 33 or C 29 stereo preamplifier. It provides the ability to control both the AC power to a remote amplifier and the ON/OFF func-

tions of the Main and Remote loudspeakers. Preamplifier front panel pushbuttons provide the control for the SCR 2 through a low voltage supply in the preamplifier.

McINTOSH MR 75

AM-FM STEREO TUNER

The McIntosh MR 75 AM-FM Stereo Tuner is a superb tuner using the latest high technology circuits. This fine tuner will discover more FM stations with good quality than ever before.

FM AUTOMATIC FREQUENCY LOCK

The Automatic Frequency Lock (AFL) is a patented McIntosh circuit that activates when you tune to the center frequency of an FM station. When the center ON-STATION vertical LED indicator lights, there will be no drift from accurate tuning, insuring minimum distortion and best performance.

AUTOMATIC STEREO NOISE SUPPRESSION

When listening to weak or distant FM stations, optimum stereo separation and signal to noise ratio is automatically provided by a third generation phase locked loop stereo decoder.

UNIQUE AM TUNER SECTION

The AM tuner's design is unique for a superheterodyne receiver. It has constant selectivity, constant sensitivity and high image rejection across the band. There is no loss of frequency response at the low end of the band, the only AM circuit with all these performance features.

PERFORMANCE LIMITS AND RATINGS

FM SECTION

TUNING:

88 to 108 MHz

ANTENNA INPUTS:

One 300W balanced and one 75W unbalanced.

INTERMEDIATE FREQUENCY:

10.7 MHz

USABLE SENSITIVITY:

2mV (11.2 dBf) IHF

QUIETING SENSITIVITY:

5mV (19.1 dBf) IHF -50 dB (Mono)

50mV (39.5 dBf) IHF -50 dB (Stereo)

SIGNAL TO NOISE RATIO:

70 dB IHF minimum both Mono and Stereo

HARMONIC DISTORTION:

0.18% (Mono) IHF maximum

0.38% (Stereo) IHF maximum

ALTERNATE CHANNEL SELECTIVITY:

75 dB IHF minimum

IMAGE REJECTION:

100 dB IHF minimum

STEREO SEPARATION:

45 dB minimum at 1 kHz

AUDIO FREQUENCY RESPONSE:

20 Hz to 15 kHz +0, -1 dB

CAPTURE RATIO:

1.8 dB

SELECTIVITY:

75 dB IHF minimum

SPURIOUS REJECTION:

100 dB IHF minimum



SCA REJECTION:

60 dB minimum

AM SECTION

SENSITIVITY:

75mV IHF with external antenna

SIGNAL TO NOISE RATIO:

45 dB minimum IHF or 55 dB at 100% modulation

FREQUENCY RESPONSE:

+0 -6 dB from 20 Hz to 3500 Hz

HARMONIC DISTORTION:

0.8% maximum at 30% modulation

ADJACENT CHANNEL SELECTIVITY:

30 dB minimum IHF

IMAGE REJECTION:

65 dB minimum from 550 kHz to 1600 kHz

GENERAL INFORMATION

AUDIO OUTPUT:

Variable:

2.5V into 47kW

Fixed:

1V into 47kW

AUDIO HUM:

75 dB down from 100% modulation

POWER REQUIREMENT:

120 Volts 50/60 Hz, 20 Watts

SEMI CONDUCTOR COMPLEMENT:

22 Bipolar Transistors

4 Field Effect Transistors

23 Silicon Diodes

15 Integrated Circuits

19 LED's

2 Bridge Rectifiers

MECHANICAL INFORMATION

SIZE:

Front panel measures 16 inches wide (40.6 cm) by 5 7/16 inches high (13.8 cm). Chassis measures 14 3/4 inches wide (37.5 cm) by 4 13/16 inches high (12.2 cm) by 13 inches deep (33 cm), including connectors. Knob clearance required is 1 1/4 inches (3.2 cm) in front of mounting panel.

FINISH:

Front panel is anodized gold and black with special gold/teal nomenclature illumination. Chassis is black.

MOUNTING:

Exclusive McIntosh developed professional PANLOC

WEIGHT:

23 pounds (10.43 kg) net, 35 pounds (15.88 kg) in shipping carton.

15 YEARS OF BASIC CIRCUIT AND CONCEPT RESEARCH HAS DEVELOPED THE TECHNOLOGY NECESSARY FOR A TRULY LOW DISTORTION FM TUNER WITH VARIABLE SELECTIVITY . . .

THE MCINTOSH MR 78!



McIntosh research is a continuous program of exploration for technology that permits performance improvement and greater value for you. This unrestricted research program developed the technology necessary for the realization of these design concepts for the MR 78.

THE DISTORTIONLESS IF FILTER

Ever since the beginning of FM, research engineers have realized that constant delay IF filters equivalent to linear-phase were necessary for low distortion reception. Crude approximations to constant delay have always been used in FM tuners - with disappointing results. So-called "Butterworth" or "Legendre" filters offer only a fair compromise with respect to delay error. Crystal and ceramic filters, usually based on the "Chebychev" model, work fairly well and give good selectivity, but none of these are constant delay linear-phase, filters. Commercial tuners using these filters can show 5% stereo IM distortion at 100% modulation. The filters used in most of today's tuners can have delay errors up to 100%! The IF filter in the MR 78 has a delay error of less than 1% from antenna input to discriminator output! In its useful bandpass, it is a true mathematical approximation to linear-phase. It is the world's finest selective, linear-phase, minimum-phase shift filter.

A FORTRAN computer program using an algorithm that took six years to develop was used in its design. The mathematical complexity of the filter design procedure is almost beyond belief. Using a process called "numerical integration in the complex S-plane," a high speed IBM computer was used on the design of the IF filter. A human engineer, working twenty-four hours a day and seven days a week, would have taken 300 years to finish this work . . . assuming he made no mistakes!

VARIABLE SELECTIVITY

The MR 78 has variable selectivity. In SUPER-NARROW the IF bandwidth is 210 kHz wide at 60 dB down and permits tuning stations that are impossible on ordinary tuners. The great number of stations crowding the FM band requires a tuner with variable selectivity.

In the NORMAL position, a very low distortion 8-pole filter is used in the IF circuit.

The NARROW position adds a sharp 8-pole filter to the NORMAL IF filter to yield a low distortion (less than 0.2%), highly selective 16-pole composite IF filter.

SUPER-NARROW position adds a 4-pole 4-zero crystal filter to the two other IF filters. SUPER NARROW permits receiving distant stations which are on channels adjacent to local stations. With an adequate FM antenna there are usable signals never heard before with ordinary FM tuners.

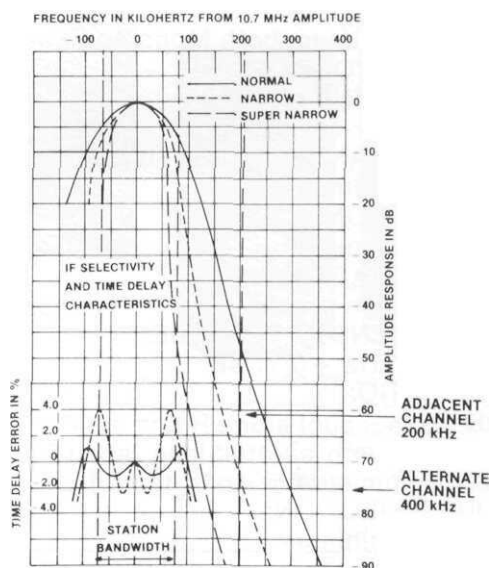

The MR 78 tuner uses linear phase filters at the NORMAL and the NARROW positions of the SELECTIVITY switch settings.

LINEAR PHASE BRIDGE DISCRIMINATOR

The excellence of the IF filter would be useless if it had to work into an ordinary FM detector. Thus a new detector with suitably low distortion had to be developed. A search of the available literature revealed a little-known bridge circuit with a theoretical distortion of zero! However, designing a practical working circuit for a commercially feasible stereo tuner took some doing. A U.S. patent is held by McIntosh on this circuit.

Distortion performance of the new McIntosh bridge detector is close to the theoretical zero. In addition to its excellent distortion performance, the bridge detector also exhibits a capture ratio close to 0 dB.

FRONT END

Instead of using a conventional, easily overloaded transistor or FET as a straight RF amplifier, the MR 78 uses a rugged Junction Field Effect Transistor as an impedance converter to drive a 5-watt power transistor. This combination, a cascode circuit, makes the RF amplifier virtually impossible to overload or cross-modulate. As an example, if you are tuned to a 3 microvolt signal at 96.3 MHz, the MR 78 will reject signals elsewhere on the dial which are at least, 4,000,000 times stronger. Thus, a 12 volt signal received at 104.3 MHz would not interfere with the signal at 96.3 MHz.

The front end oscillator uses a high-Q ceramic form tank coil. It is free from spurious radiation, and operates at high efficiency.

Adding to the superior design of the front end is the integrated circuit balanced mixer. It is practically impossible to overload. Oscillator pulling, cross modulation, and other types of distortion so common in ordinary transistor or FET mixers is minimized.

PERFORMANCE LIMITS and RATINGS

TUNING RANGE:

88 to 108 MHz.

ANTENNA INPUTS:

300 ohms balanced; 75 ohms unbalanced.

INTERMEDIATE FREQUENCY:

10.7 MHz.

SENSITIVITY:

2mV for 35 dB quieting; 2.5 mV at 100% modulation (\pm 75 kHz deviation) for 3% total noise and harmonic distortion.

SIGNAL TO NOISE RATIO:

75 dB below 100% modulation.

HARMONIC DISTORTION:

0.2% mono or stereo at 100% modulation, 20 Hz to 15,000 Hz. Typically, 0.05% at 1,000 Hz.

DRIFT:

25,000 Hz for the first two minutes; thereafter 5,000 Hz at 25° C in 24 hours.

FREQUENCY RESPONSE:

Mono: \pm 1 dB 20 Hz to 20,000 Hz with standard de-emphasis, (75 mS); Stereo: \pm 1 dB 20 Hz to 15,000 Hz with standard de-emphasis (75 mS).

CAPTURE RATIO:

0.25 dB detector only; 2.5 dB complete tuner.

SELECTIVITY: Switch Setting:

	NORMAL	NARROW	SUPER NARROW
Adjacent Channel	7 dB	22 dB	55 dB
Alternate Channel	55 dB	>90 dB	>>90 dB

SPURIOUS REJECTION:

100 dB IHF.

IMAGEREJECTION:

100 dB at 88 to 108 MHz (IHF).

INTERMODULATION DISTORTION:

0.2% mono or stereo for any combination of frequencies from 20 Hz to 15,000 Hz with peak modulation equal to 100% or less. Typically 0.1 %.

MAXIMUM SIGNAL INPUT:

12 volts across 300 ohm antenna terminals will not increase harmonic or intermodulation distortion.

AUDIO HUM:

75 dB down from 100% modulation..

MUTING:

70 dB noise reduction between stations.

MUTING THRESHOLD (Typical):

DISTANT 5 mV; LOCAL 20 mV

SCA FILTER:

50 dB down from 67 kHz to 74 kHz; 275 dB per octave slope.

STEREO SEPARATION:

40 dB at 1,000 Hz.

STEREO FILTER (Typical):

10 dB noise reduction in Position 1.

20 dB noise reduction in Position 2.

AUDIO OUTPUT:

Front Panel Controlled: 2.5 volts into 47,000 ohms;
Fixed Output: 2.5 volts into 47,000 ohms, 1.0 volts into 600 ohms.

All tuner performance limits were measured with SELECTIVITY switch set at NORMAL, unless otherwise slated.

GENERAL

POWER REQUIREMENT:

120 volts, 50/60 Hz 35 watts.

SEMICONDUCTOR COMPLEMENT:

3 JFET, 2 MOSFET, 17 Bipolar Transistors, 43 Diodes, 4 Integrated Circuits.

MECHANICAL

SIZE:

Front panel: 16 inches wide (40.64 cm) by 5-7/16 inches high (13.81 cm); Chassis: 15 inches wide (38.1 cm) by 13 inches deep (33.02 cm), including PANLOC shelf and back panel connectors; Knob Clearance: 1-1/2 inches (3.81 cm) in front of mounting panel.

FINISH:

Front panel: Anodized gold and black with special gold/teal panel nomenclature illumination; Chassis: Chrome and black.

MOUNTING:

McIntosh developed professional PANLOC.

WEIGHT:

27 pounds (12.25 kg) net, 39 pounds (17.69 kg) in shipping carton.

Electronic Laboratories'

PRODUCT ANALYSIS

THE McIntOSH MR78 FM/FM STEREO TUNER



Fig. 1 — Front view

MANUFACTURER'S PUBLISHED PERFORMANCE LIMITS (SPECIFICATIONS):

Tuning Range: 88 to 108 MHz. Antenna Inputs: 300 ohms balanced; 75 ohms unbalanced. Intermediate Frequency (IF): 10.7 MHz Sensitivity: 2 mV for 35 dB of quieting; 2.5 mV at 100% modulation (± 75 kHz deviation) for 3% total noise and harmonic distortion. Signal to Noise Ratio: 75 dB below 100% modulation. Harmonic Distortion: 0.2% 20 Hz to 15,000 Hz, mono or stereo at 100% modulation. Typically, 0.05% at 1000 Hz. Drift: 25,000 Hz for the first two minutes; thereafter 5,000 Hz at 25° C in 24 hours. Frequency Response: MONO ± 1 dB 20 Hz to 20,000 Hz with standard deemphasis, (75 mS). STEREO ± 1 dB 20 Hz to 15,000 Hz with standard deemphasis, (75 mS). Capture Ratio: 0.25 dB detector only; 2.5 dB complete tuner. Selectivity (IHF): Adjacent Channel: set switch to: normal, 7 dB; narrow, 22 dB; super narrow, 55 dB. Alternate Channel: set switch to: normal, 55 dB; narrow, 90 dB; super narrow, 90 dB; super narrow, 90 dB. Spurious Rejection: 100 dB IHF. Image Rejection: 100 dB, 88 to 100 MHz, (IHF). Intermodulation Distortion: 0.2% mono or stereo for any combination of frequencies from 20 Hz to 15,000 Hz with peak modulation equal to 100% or less. Typically 0.1%. Maximum Signal Input: 12 volts across 300 ohms antenna terminals will not increase harmonic or intermodulation distortion. Audio Hum: 75 dB down from 100% modulation. Muting: 70 dB noise reduction between stations. Muting Threshold: (Typical): Distant position 5 mV; Local position 20 mV. SCA Filter: 50 dB down from 67 kHz to 74 kHz; 275 dB per octave slope. Stereo Separation: 40 dB at 1,000 Hz. Stereo Filter: (Typical): 10 dB noise reduction in Position 1; 20 dB noise reduction in Position 2. Audio Output: Front panel controlled: 2.5 volts into 47,000 ohms. Fixed output: 2.5 volts into 47,000 ohms; 1.0 volt into 600 ohms. (All tuner performance limits were

measured with SELECTIVITY switch set at NORMAL, unless otherwise stated.)

GENERAL SPECIFICATIONS:

Power Requirements: 120 volts, 50/60 Hz, 35 watts. Semiconductor Complement: 3 J FET's. 2 MOS FET's, 17 Bipolar Transistors, 43 Diodes, 4 Integrated Circuits.

MECHANICAL SPECIFICATIONS:

Size: Front Panel: 16 inches wide (40.64 cm) by 5-7/16 inches high (13.81 cm); Chassis: 15 inches wide (38.1 cm) by 13 inches deep (33.02 cm), including PANLOC shelf and back panel connectors; Knob clearance 1-1/2 inches (3.81 cm) in front of mounting panel. Weight: 27 pounds (12.25 kg) net, 39 pounds (17.69 kg) in shipping carton. Finish: Front panel; Anodized gold and black with special gold/teal panel nomenclature illumination; Chassis: Chrome and black. Mounting: McIntosh developed professional PANLOC.

Most of the semi-technical literature intended for audio-ophile-consumer education deals with the specifications of an FM or a stereo FM tuner as though each were mutually independent of the others. For example, we are at once told that "good selectivity" (the ability to tune to stations closely spaced in frequency without encountering interference from nearby stations on the dial) and wide bandwidth as well as low distortion are mutually exclusive parameters. We are also led to believe that a tuner "should have ultra low harmonic or intermodulation distortion", but we are hardly ever told that such low distortion can only be achieved if the IF bandwidth of the tuner is sufficiently broad (and linear in phase) to accommodate the upper modulation sidebands of the incoming signal which may well extend well beyond the nominal 150 kHz which is supposed to represent the "maximum bandwidth" of a given FM channel. But if bandwidth is broadened to accommodate such extreme sidebands (which occur particularly during stereo FM transmissions), how is it possible to achieve high orders adjacent channel (or even alternate channel) selectivity? Excellent stereo separation at high audio frequencies is also dependent upon adequate bandwidth, so that again, such high orders of separation are in conflict with high orders of selectivity. What's to be done? Most tuner manufacturer's content themselves with a series of trade-offs. Selectivity figures are made high enough (without sacrificing low distortion and good separation) so that in most listening areas adjacent-channel or co-channel interference will not pose much of a problem most of the time. McIntosh has attacked the problem in a more logical and direct method — by providing variable selectivity on their MR 78 tuner. But more of this shortly.

The front panel of the McIntosh MR 78 maintains the traditional "Mac" look of "black glass" and features that company's well known PANLOC mounting method (shelves and shelf mounting brackets, together with necessary mounting hardware are, as usual, supplied) as pictured in Fig. 1. The large, illuminated dial area at the upper center of the panel has a linear dial scale, calibrated at every half MHz, as well as a 0-100 logging scale for easy referencing of favorite stations. The smooth traveling dial pointer is

illuminated over a portion of its length. Also located within the dial opening are symmetrically positioned center-of-channel and signal-strength meters. To the left of the dial area are two rectangular areas denoted as "function" and "selectivity". Illuminated words "stereo", "filter", and "muting" appear (when selected) in the upper area, while the lower area is illuminated with either the notation "-7 dB", "-22 dB" or "-55 dB". These correspond to the three selectivity settings of the selectivity switch just below. The dB numbers represent adjacent channel selectivity and should not be confused with the more familiar alternate channel selectivity values which are, of course, much greater. A large tuning knob, coupled to a backlash-free flywheel and dial string arrangement, is located to the right of the dial area opening.

In addition to the selectivity switch, other rotary controls along the bottom section of the front panel include a meter selector switch which chooses either the signal strength or multipath indication function of the signal-strength meter, a filter switch which, in addition to having an "off" position, has two settings for noise reduction during weak-signal stereo FM reception, a muting switch, with positions for local and distant reception (which varies the muting threshold), a mode switch with "stereo only", mono, and "stereo auto" positions and a volume control which also turns power on and off to the tuner.

The rear panel of the MR 78 has a pair of test points, as illustrated in Fig. 2., which are intended for use with the McIntosh Maximum Performance Indicator, an accessory product marketed by that company. A fuseholder cap is also accessible from the rear for replacement, if necessary, of the tuner's 0.5 ampere slo-blow line fuse. Push-type



Fig. 2 — View of back panel

terminals are supplied for 300-ohm antenna transmission line connection, while a 75-ohm coaxial connector is offered for connection of that type of transmission line. Two sets of audio output jacks (one pair for fixed output, the other controlled by the front-panel volume control) and one convenience AC receptacle complete the rear panel layout.

Internal Construction and Circuit Highlights

As can be seen in the internal view of the chassis, Fig. 3, the McIntosh MR 78 is extensively shielded. Six major circuit board modules are used in addition to the RF front end. These include the IF circuit board, the selectivity selection junction board, the multiplex section, the detector circuit board, the output amplifier board and the power supply circuit board. The front end utilizes a 5-section tuning capacitor. A junction FET is used as impedance converter to drive a 5-watt power transistor in the RF stage for high overload capability. An antenna matching circuit at the RF input has a two-position selectable switch which alters the RF bandpass characteristics of the input circuit. The switch

positions are labelled "Lo Gain" and "Hi Gain", a bit confusing unless the user reads the manual carefully and discovers that the gain references refer to the antennas which might be used with the tuner. Thus, the Lo Gain position is intended for use in seeking out distant or weak signals

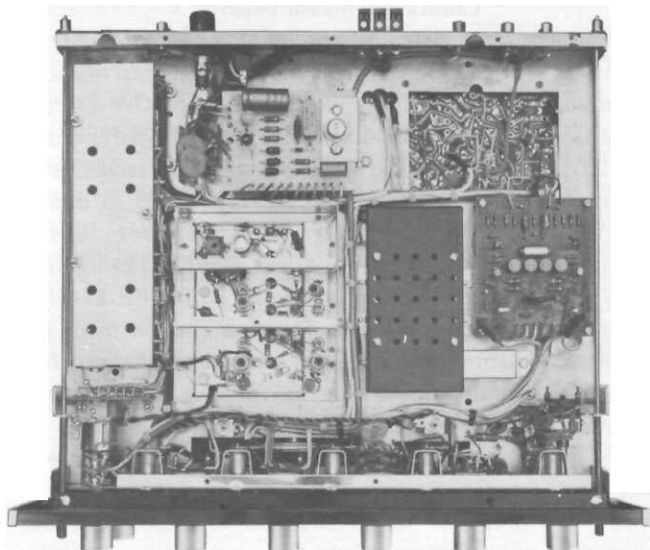

Fig. 3. — View of chassis layout

while, in most applications, the "Hi Gain" position should be used since it yields the lesser amount of RF signal at the input to the RF amplifier stage, as well as a sharper bandpass characteristic.

A block diagram of the RF and IF sections of the MR 78 is reproduced in Fig. 4. A balanced integrated circuit mixer stage is used as a further safeguard against possible overload and to reduce oscillator pulling. Its 0.7 MHz output is coupled to the IF amplifier section by means of a bifilar transformer. Linear phase filters are used in both the NORMAL and NARROW selectivity settings of the MR 78, while for the SUPER-NARROW selectivity setting, a 4-pole, 4-zero crystal filter having constant delay, is introduced into the IF chain. McIntosh developed a new type of FM detector for this tuner which they call a linear phase bridge discriminator. It uses a balanced transmission line bridge in conjunction with a differential voltage doubling circuit to achieve ultra-low orders of distortion in the demodulated FM audio signals.

A block diagram of the Multiplex and Audio Sections is illustrated in Fig. 5. An IC audio amplifier with over 120 dB of negative feedback in two feedback loops is used to drive the stereo demodulator. Muting, "stereo only" tuning and automatic mono/stereo switching are all functions which are performed within the stereo decoder circuitry. A stereo filter circuit follows the matrix decoder and de-emphasis networks to reduce noise when tuning to weak stereo stations. This filter employs a twin-T bandpass filter design to suppress noise while only minimally affecting stereo separation and imaging. The audio amplifier section consists of a pair of two-transistor amplifiers, one for each channel. Each amplifier delivers 2.5 volts to the fixed output jacks and to the volume control sections which feed the

variable output jacks. The power supply section consists of a 24-volt regulated supply which uses electronic filtering and supplies power to all signal stages, while a second, half-wave rectifier supply also equipped with electronic filter circuits feeds the necessary DC voltages to the multiplex decoder section.

Laboratory Measurements

Although most listening situations require selectivity settings of NORMAL on the MR 78, we decided to measure performance in this setting as well as the NARROW selectivity setting. In the NORMAL setting, IHF sensitivity measured 2.0 mV (11.2 dBf) and 50dB quieting was reached with an input signal strength of 3.0 mV (14.7 dBf) in mono. Referring back to the published specifications, readers will note that McIntosh has not as yet seen fit to bring their specs into line with the newly adopted IHF/IEEE/EIA FM Tuner Measurement standards. Thus, no claim is made for the 50 dB quieting sensitivity, for example, and Mac offers us a 35 dB quieting point instead. While we recognize that McIntosh has, in the past, differed with the rest of the industry in the matter of publishing specifications, we do feel that the new tuner standards are worth following and would hope that if they have not already done so, McIntosh would bring their published specs into line so that they might be easily compared with those of other companies. Be that as it may, 3.0 mV (14.7 dBf) is a very respectable figure for 50 dB quieting. Stereo sensitivity was 4.5 mV (18.3 dBf), at which signal strength in stereo was sufficient to cause nearly 35 dB of quieting. 50 dB of quieting in stereo was attained with an input signal of 32 mV (35.3 dBf). Ultimate S/N in mono was an incredibly high 81 dB (we never thought our signal generator could read that low — now we know it can), while in stereo, best quieting for strong signals was 73 dB. Total harmonic distortion in mono was a low 0.06%, while in stereo, for the same strong signals used, THD read 0.1% at 1kHz. Curves of results obtained in the Normal selectivity setting are plotted in Fig. 6.

Switching to the NARROW selectivity setting, S/N readings in both mono and stereo remained virtually the same, but, as was to be expected, THD readings increased slightly, to 0.08% for mono and 0.35% for stereo. These results are shown in Fig. 7.

Returning to the NORMAL selectivity setting, we measured a capture ratio of 1.8 dB. Alternate channel selectivity was 57 dB for this setting, while image and spurious rejection were both in excess of 100 dB (the limits of our test equipment). Maximum deviation from ideally flat frequency response, for both mono and stereo, was less than 1.0 dB, with the deviation approaching that number at 15 kHz but remaining within 0.2 dB at frequencies from 10 kHz down to 50 Hz. Muting threshold occurred at 7.0 mV for the "distant" position, 30 mV for the "local" position. Stereo switching occurred at around 4.0 mV (17.2 dBf).

Stereo separation measured 52 dB at mid frequencies for the normal selectivity position, decreasing to 43 dB at 100 Hz and 36 dB at 10 kHz, as plotted in Fig. 8. In order to properly ascertain the THD produced by the tuner at high modulating frequencies it was necessary for us to employ our spectrum analyzer and to "sum" the harmonic products mathematically to arrive at the 0.14% THD figure shown

for a 10 kHz modulating frequency. If this is not done, super-audible products (not properly identifiable as harmonic distortion) "cloud" the single-reading measurement that is obtained on a conventional meter-type distortion analyzer.

Fig. 9 is a plot of separation versus frequency with the selectivity control set to the NARROW position. Separation naturally suffers somewhat when this narrow setting is used, but remains well above 30 dB for most frequencies tested. Distortion in stereo also rose somewhat in the narrow setting, as shown in the curves of Fig. 9. While in mono, THD remained incredibly low at mid-frequencies even when the narrow setting of the selectivity switch was used. Sub-carrier product rejection was so good that it was not even necessary to use the recommended 15 kHz low-pass filters for all of our high-frequency noise and distortion measurements, except as already noted for the 10 kHz readings. Audio output level was exactly 2.5 volts, as claimed, for a 100% modulation signal at the fixed output terminals. Since our own signal generating equipment is limited to 0.2 volts output, there was no way for us to verify McIntosh claims regarding 12 volt antenna input overload capability, though we have no reason to doubt the claim, based on subsequent strong-signal listening tests. We purposely carted the tuner over to a mid-city location where we have access to a listening room that is just a few blocks away from several high-powered FM transmitters.

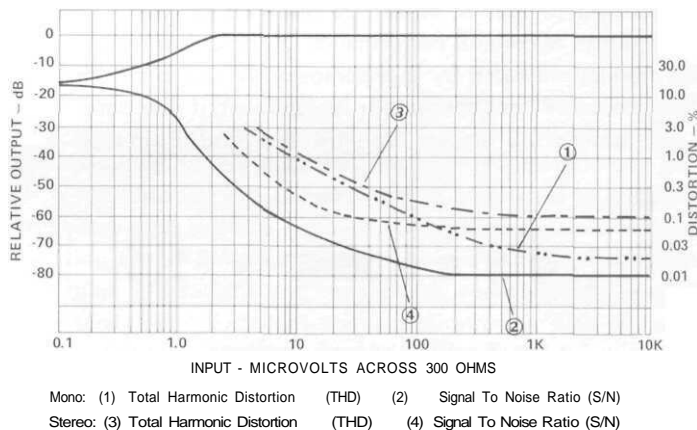

Fig. 6 — FM quieting and distortion characteristics (with selectivity switch set to "NORMAL")

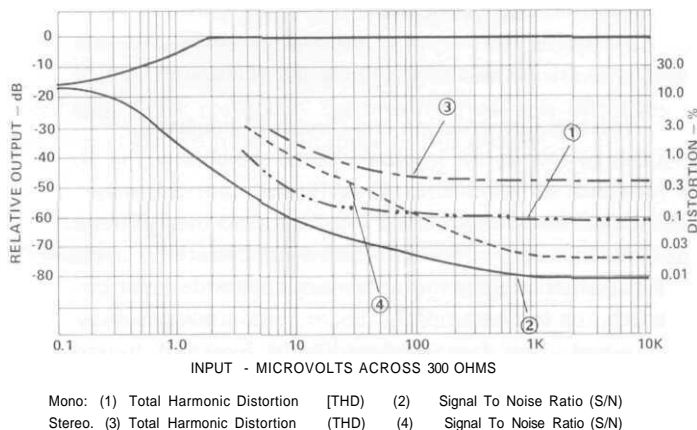

Fig. 7 - FM quieting and distortion characteristics (with selectivity switch set to "NARROW")

if he could have heard FM the way we heard it over the Mac MR 78.

There was only one instance where we found it necessary to use the SUPER-NARROW position of the selector switch, and that was when we were trying to listen to a weak signal originating some 120 miles from our listening location — one nestled between a stronger signal 200 kHz below it, and a much stronger local station, 200 kHz on the higher side of the dial. If you've ever tried to receive that kind of signal on a lesser tuner, you'll know what we mean. In any case, when we did switch to the SUPER-NARROW position, we actually were able to listen to the desired distant station and distortion, though audibly higher, was still at tolerable levels.

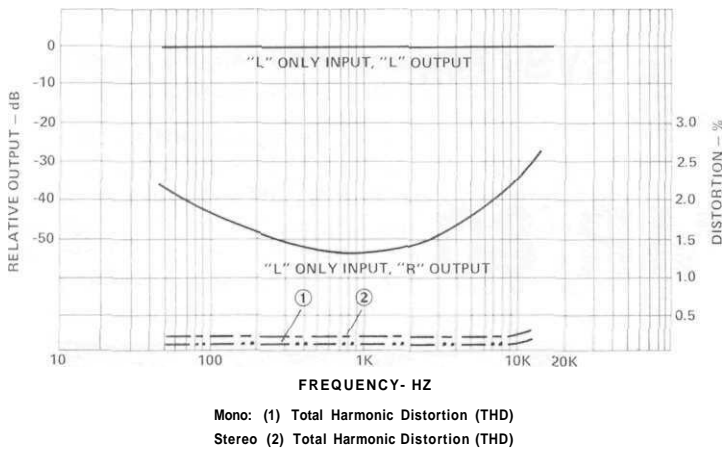

Fig. 8 — Separation and distortion versus frequency (with selectivity switch set to "NORMAL")

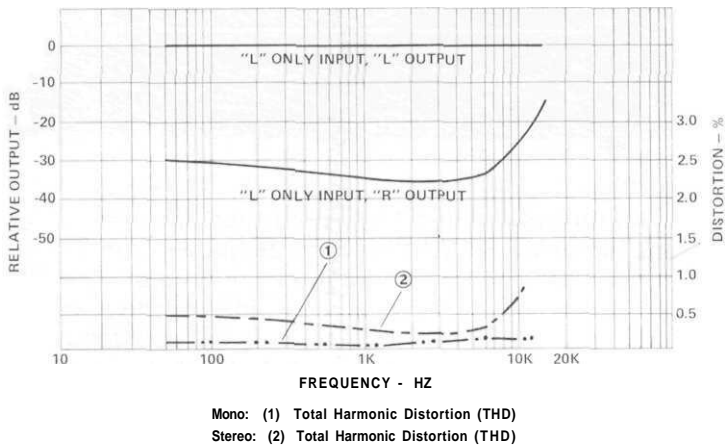

Fig. 9 - Separation and distortion versus frequency (with selectivity switch set to "NARROW")

Previously, we had measured signal voltages of 2 to 3 volts at that location and found that most tuners did exhibit cross-modulation and other overload effects. With the "Mac" tuner, we were able to clearly separate closely spaced high-signal stations on the dial with nary a trace of interference from other strong-signal stations in the same vicinity.

Other Use and Listening Tests

Back in our lab (some 20 miles from the city), we began to appreciate the importance of that selectivity switch on the front panel. If you are an inveterate FM DX-er, you will be amazed (as we were) at how many signals you can separate and receive clearly by using the narrow (and at times even the super-narrow) selectivity switch positions on the MR 78. Here is a tuner that doesn't compromise between low distortion and wide bandwidth. 55 dB of selectivity (that claimed in the NORMAL setting) is no problem if you are not plagued by adjacent and alternate channel signals. In fact, the normal setting, coupled with those linear phase filters in the IF section, rendered the kind of reception from the few good quality stations that we have in our listening area that we had often dreamed about- Program quality varied, of course, but when we were fortunate enough to tune to a live concert (yes, we still do have some live FM programming in this area, albeit at midnight each night), the results were truly astounding. We had the feeling that the late Major Armstrong, too, would have smiled

THE MOST FLEXIBLE CONTROL SYSTEM EVER FOR A DIGITAL DISPLAY PROFESSIONAL FM TUNER

The McIntosh MR 80



Engineering direction dictated a tuner design governed by insistence on great flexibility and ease of use. This had to be done while designing for great sensitivity and the world's best selectivity in keeping with the needs of low distortion. These values were achieved. They retain the McIntosh reputation for outstanding performance, long life and reliability.

To assure long term trouble free operation, tuning a station on the MR 80 is achieved electronically. The MR 80 can be tuned four different ways:

1. Manual tuning by rotating the main tuning knob
2. Auto Scan automatically searches for the next available station up or down the dial
3. Presets allow you to select the four most listened to stations at the touch of your finger tip
4. Remote Scanning will allow the MR 80 to be tuned to a station from a wired remote location.

Two separate antenna systems can be connected to the MR 80: 1) An outdoor or indoor FM antenna, or 2) a cable from your local cable company. The antenna selection is controlled by an electronic switching device.

The MR 80 uses electronic varactor tuning instead of the more conventional mechanically ganged variable tuning capacitors. Variable tuning capacitors can with age collect dust and dirt, reducing their performance. McIntosh uses double varactor diodes to provide the necessary tracking between the different tuned RF stages. When a weak distant station is adjacent to a strong local station the Preselector switch will add in an additional tuned circuit providing an extra degree of selectivity to reduce the interference from the adjacent strong station.

After the RF amplifier two parallel tuned circuits are used to provide the proper load impedance for the bipolar transistor. These two tuned circuits greatly improve the image rejection and overload performance of the tuner, as well as increasing the RF selectivity.

An innovative new lock circuit was developed for use in the MR 80. This new circuit allows correct tuning without the use of a center tune meter. The MR 80 will be correctly tuned regardless of the stations transmitted signal as related to its assigned frequency. Two operational amplifiers cause the lock circuit to track a station even if it drifts 1 MHz.

The mixer is a balanced matched dual J-FET and bipolar transistor circuit.

After the mixer the signal is electronically switched to go either directly to the IF amplifier or to go through a quartz crystal filter. The MR 80 has the narrowest IF bandwidth ever used in a stereo tuner. It is the correct width to let just one FM station through. The excellent selectivity of the MR 80 (210 kHz wide at 60 dB down) permits tuning stations that are impossible to receive on ordinary tuners.

The SUPER NARROW selectivity position adds a 4 pole - 4 zero crystal filter to the other 5 IF filters. SUPER NARROW permits listening to stations not heard with most other FM tuners. The 5 stages of IF amplification provide the necessary gain to reduce noise in the signal and the interference from other stations. They are piezoelectric fixed frequency filters in place of normal tuned circuits. An advantage the IF stages will always stay in alignment, even with age.

The signal strength indicator column is the sum of all IF stages instead of just one it indicates the signal strength throughout the entire IF system.

The selectivity section of the IF amplifier is the LIMITER with a total gain of 80 dB. The use of very high gain in the limiter circuit produces hard limiting with very good impulse noise rejection. Limiter bandwidth is greater than 50 MHz, producing excellent detector capture characteristics.

A broadband Foster-Seeley discriminator is used

as the detector coupled with a broadband limiter to produce unmeasurable noise and distortion.

The heart of the multiplex section is a new third generation phase locked loop (PLL) stereo decoder integrated circuit (IC). This PLL IC incorporates two special systems, an automatic variable separation control circuit to reduce background noise when receiving weak stereo stations, and tri-level digital waveform generation which eliminates interference from SCA signals and from the sidebands of adjacent channel FM signals.

The variable separation control is operated from the IF amplifier's signal strength detector. A smooth transition is provided from mono to stereo or from stereo to mono at weak signal levels to provide the optimum signal to noise ratio and best stereo separation for the prevailing signal conditions. The circuit operates only during stereo reception. It switches automatically to monophonic if the 19 kHz pilot tone is absent.

Additional advantages of the phase locked loop stereo demodulation are the elimination of inductors to minimize drift, integral lamp driving capability to indicate the presence of the 19kHz pilot carrier, excellent channel separation over the entire audio frequency range, extremely low distortion, low output impedance, and transient-free mono/stereo switching.

Following the MPX decoder is the three position de-emphasis switch. The three different positions allow the MR 80 to be used in North America with standard 75ms de-emphasis and in Western Europe and the Far East with 50ms de-emphasis. A 25ms position is provided for use with an external noise reduction devices.

An electronic blend filter circuit, using two J-FETs of a quad J-FET package, reduces out of phase noise when in the stereo mode and when tuned to a weak station. The filter is a twin-T bandpass that blends the high and low frequencies, leaving separation unaffected at mid-frequencies. This results in a greatly improved stereo image when the filter is required.

Special design attention has been given to the power supply section. Nine separate power circuits are used. Six of these are regulated to prevent loss of performance during a brown out.

PERFORMANCE LIMITS and RATINGS

TUNING:

88 to 108 MHz

ANTENNA INPUTS:

One 300W balanced or two 75W unbalanced.

INTERMEDIATE FREQUENCY:

10.7 MHz

SENSITIVITY:

9.3 dBf (1.6mV) for 35 dB of quieting

14.7 dBf (3mV) for 50 dB of quieting

13.2 dBf (2.5mV) for 3% total noise and harmonic distortion

SIGNAL TO NOISE RATIO:

75 dB below 100% modulation

HARMONIC DISTORTION:

0.2% 20 Hz to 15 kHz, mono or stereo

Typically, 0.08% at 1000 Hz

INTERMODULATION DISTORTION:

0.15% mono or stereo for any combination of frequencies from 20 Hz to 15,000 Hz with peak modulation equal to 100% or less. Typically 0.1 %

FREQUENCY RESPONSE:

Mono and Stereo ± 1 dB 20 Hz to 15 kHz with 75, 50 or 25mS de-emphasis

CAPTURE RATIO:

1.5 dB

SELECTIVITY:

	Narrow	Super Narrow
Adjacent channel	8 dB	60 dB
Alternate channel	90 dB	110 dB

SPURIOUS REJECTION:

110 dB

TUNER IM (RF):

-23dBm for 2 signals 1 MHz apart

TUNER INTERCEPT POINT:

-10 dBm 75W

IMAGE REJECTION:

90 dB

MAXIMUM SIGNAL INPUT:

8 volts across 75W (1W) antenna terminal will not increase harmonic or intermodulation distortion.

AUDIO HUM:

75 dB down from 100% modulation

MUTING:

70 dB noise reduction between stations

MUTING THRESHOLD:

2mV to 1000mV

SCA REJECTION:

60 dB minimum

STEREO SEPARATION:

50 dB to 1000 Hz

STEREO FILTER:

10 dB noise reduction

AUDIO OUTPUT:

Variable: 2.5V into 47k

Fixed: 1V into 47k

GENERAL INFORMATION

POWER REQUIREMENTS:

120 volts 50/60 Hz. 25 watts

SEMICONDUCTOR COMPLEMENT:

57 Transistors, 68 Integrated Circuits, 81 Diodes, 4 LED Displays, 18 LED's, 7 Neon Lamps

MECHANICAL INFORMATION

SIZE:

Front panel measures 16 inches wide (40.6 cm) by 5 7/16 inches high (13.8 cm). Chassis measures 14 3/4 inches wide (37.5 cm) by 4 13/16 inches high (12.2 cm) by 13 inches deep (33 cm), including connectors. Knob clearance required is 1 1/4 inches (3.2 cm) in front of mounting panel.

FINISH:

Front panel is anodized gold and black with special gold/teal nomenclature illumination. Chassis is black.

MOUNTING:

McIntosh developed professional PANLOC.

WEIGHT:

27 pounds (12.2 kg) net, 39 pounds (17.7 kg) in shipping carton.

Electronic Laboratories'

PRODUCT ANALYSIS

THE McINTOSH MR 80 DIGITAL FM/FM STEREO TUNER



Fig. 1 - Front panel view of McIntosh MR 80 Tuner

MANUFACTURER'S PERFORMANCE LIMITS:

Sensitivity: 9.3 dBf (1.6 uV) for 35 dB of quieting; 14.7 dBf (3 uV) for 50 dB of quieting; 13.2 dBf (2.5 uV) for 3% total noise and harmonic distortion (IHF Usable Sensitivity). Signal-to-Noise Ratio: 75 dB (mono). Harmonic Distortion: 0.2%, 20 Hz to 15 kHz, mono or stereo; typically 0.08% at 1 kHz. IM Distortion: 0.1 5% mono or stereo, any combination of frequencies, from 20 Hz to 15 kHz, with peak modulation equal to 1 00% or less. Typically 0.1 %. Frequency Response: Mono and stereo ± 1 dB 20 Hz to 15 kHz, with 75, 50 or 25 microsecond de-emphasis. Capture Ratio: 1.5 dB. Selectivity: (Alternate Channel): 90 dB, narrow; 110 dB super-narrow; (Adjacent): 8 dB narrow; 60 dB super-narrow. Spurious rejection: 1 1 0 dB. Image Rejection: 90 dB. Maximum Signal Input: 8 volts across 75 ohm antenna input. Audio Hum: 75 dB down from 1 00% modulation. Muting: 70 dB noise reduction between stations. Muting Threshold: 2 uV to 1000 uV (variable). SCA Rejection: 60 dB or more. Stereo Separation: 50 dB at 1 kHz. Stereo Filter: 1 0 dB noise reduction. Audio Output: Variable, 2.5 V into 47k ohm; Fixed, 1V into 47k ohm.

GENERAL SPECIFICATIONS:

Power Requirements: 120 volts, 50/60 Hz, 25 watts. Dimensions: (Front Panel): 1 6" w x 5-7/1 6" h. (Chassis): 14-3/4" w. x 4-13/16" h. x 13" d. Weight: 28 lbs. net.

At your request, we have conducted an impartial evaluation of your Model MR 80 Stereo FM Tuner in our laboratory. In addition to extensive measurement data which we obtained, we have also used the sample tuner in extended listening tests over a period of several weeks, employing both a multi-element outdoor directional antenna with a motorized rotor, and a simple indoor dipole antenna made up of 300-ohm twin lead.

Our detailed conclusions are summarized at the end of this test report. In brief, however, we feel that this tuner is designed for critical listening situations where other tuners, regardless of their price, would be unable to provide satisfactory reception in the face of adjacent channel interference. A description of the unit, circuit highlights, and test results follow.

In terms of outward appearance there's no mistaking the MR 80 for anything but a McIntosh Laboratory product, with its familiar black front panel and its back-lighted nomenclature. But there is much that is new and up-to-date about this product's cosmetics, as well as its internal circuitry. Instead of a printed frequency dial scale, the upper section of the front panel is dominated by a large digital display which reads out the frequency of the tuned-to signal in Megahertz, to the nearest 100 kHz. This tuner does not employ frequency synthesis, nor does the manufacturer claim that it does. One could argue about the use of the word "digital" in connection with this tuner, since that has come to mean a frequency synthesized tuning system to a great many audiophiles, but that is largely a semantic argument these days, since many manufacturers of tuners who employ digital readout of frequency have begun to refer to such products as "digital" FM tuners.

To the left of the digital frequency display are four "touch pad" switches which are used to select one of four pre-set station frequencies. When one of these pads is touched, a small rectangle of light appears above the pad to indicate that the tuning command has been executed. To the left of these pre-set selector pads are three indicator lights. The red stereo light comes on when a stereo transmission is received. A second amber indicator light, identified by the word "lock", indicates when the tuner is locked to an incoming station signal. The third green light indicates when the stereo multiplex filter is active.

To the right of the digital frequency display is a column of tiny LED's arranged vertically, to indicate signal strength. No center-of-channel indicator is necessary since, as we shall see, the unique locking circuitry of this tuner insures proper tuning. Two more touch-pads to the right of the signal-strength column, are labelled "Auto Scan" and are used to make the tuner tune up and down the FM dial, stopping at received station signals. Finally, to the right of the auto-scan pads, we find a conventional tuning knob for manual tuning. There is a fourth method of tuning the MR 80 which we will discuss when we examine the rear panel,

The lower section of the front panel of the MR 80 is equipped with six rotary controls and a centrally located stereo headphone jack which is driven by its own audio amplifier circuitry and can deliver 2.5 volts of signal into 600 ohm loads; more than enough to drive low impedance phones, incidentally. Starting at the left, there is a two position selectivity switch, with settings identified as "narrow" and "super narrow". Normally, the "narrow" position is used and in our tests we found that it provided excellent alternate channel selectivity and the ability to

separate closely spaced signals in our listening area. We have been told by some of our friends and colleagues, however, that there are some areas of the country in which high adjacent selectivity is a must if listeners are to be able to tune to distant weak signals without being swamped by local strong station signals separated in frequency from the remote desired signal by only one channel width, or 200 kHz.

The next rotary switch activates the stereo multiplex filter circuitry, either permanently, when set to "in" or, when set to "auto" automatically whenever stereo signal strength falls below 100 microvolts or so. Since activation of the filter is always accompanied by an indicator light mentioned earlier, the listener is always aware of the filter being turned on, even if turn-on occurs automatically.

A stereo/mono mode switch follows, and to its right, beyond the headphone jack, is a continuously variable control called "scan" which determines the speed of tuning when in the scan tuning mode. A variable muting control comes next, which is used to set muting threshold and also determines scanning sensitivity, or how strong an incoming signal must be in order for the auto-scan tuning system to stop on that signal. Finally, the rightmost control located just below the tuning knob is a master output level control which determines audio level at the variable output jacks on the rear panel and which, when rotated fully counterclockwise, disconnects power to the tuner.

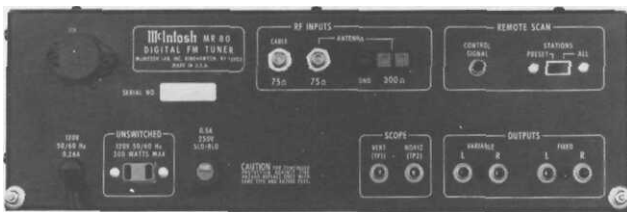

Fig. 2 Rear Panel view of McIntosh MR 80 Tuner.

The rear panel (Fig. 2) of the MR 80 is equipped with two 75-ohm coaxial antenna connectors (one of which is intended for commercial cable input), 300-ohm antenna terminals and a ground terminal. A jack nearby accepts a supplied plug which is on the end of a long remote push-button cable that allows the user either to scan or to call up the preset stations, one by one, from a remote location, depending upon the setting of a nearby slide switch. Variable and fixed level output jack pairs are at the lower right of the rear panel, while nearby are a pair of scope jacks (horizontal and vertical) intended for connection to an oscilloscope for observation of multipath (reflections) problems. A line fuseholder and an unswitched convenience AC power receptacle complete the rear panel layout.

Additional adjustment and controls are located along the top surface of the tuner. These include four continuously variable rotary controls which are used to set up the frequencies of the four desired preset stations, a rotary control which adjusts the sensitivity of the signal-strength LED column display (you can set it so that the strongest station in your area

will cause full-scale readings) and five small push-button switches. An RF preselect circuit is activated by the first of these buttons and adds a tuned circuit between the antenna and the first RF stage to immunize against strong signal overload. The next button selects the Cable or your own antenna input. The third button can be used to disable the locking circuit. The last two buttons provide selection of either 25, 50 or 75 microsecond de-emphasis characteristics.

Circuit Highlights

An electronic antenna switch selects signal inputs either from the cable input or from one of the direct antenna inputs and feeds the signal to the first RF amplifier which consists of a low-noise junction FET and a high-power bipolar transistor arranged in cascode configuration. Two PIN diodes are used to insert a second preselector stage during strong-signal reception. Tuned circuits are tuned by a series parallel connection of four matched varactor diodes which are tuned by relatively high voltage (5 to 26 volts) to eliminate diode non-linearities and possible IM distortion. Two parallel tuned circuits follow the RF amplifier to improve image rejection and increase RF selectivity.

The balanced mixer stage is a matched dual FET and bipolar transistor circuit. A low loss toroidal phase-splitting transformer is used as an impedance matching network in the gate circuit of the mixer. A bipolar transistor is used as an oscillator buffer to prevent oscillator pulling on strong signals, and as the constant current source for the dual J-FET mixer.

Four differential amplifiers, coupled with linear-phase monolithic filters, comprise the narrow selectivity and signal-strength sections of the IF amplifier. A 4-pole, 4-zero crystal filter is inserted in the signal path as well when the Super Narrow selectivity setting is selected. A solid state signal strength meter is used as a front panel indicator of incoming RF signal strength. This meter can be user-set to give a full scale indication on a signal as low as 2 microvolts or as high as 1 00,000 microvolts. Signal strength voltage is also used to control mono-stereo switching, automatic stereo filter insertion, muting, and automatic scan stop. The control voltage also adjusts stereo separation at low RF signals, so that unlike many other tuners, there is no abrupt change from mono to stereo in the presence of marginally weak signals and reduced separation also produces the best possible signal to noise ratio at weaker signal strength levels.

The limiter following the selectivity section of the IF amplifier has a total gain of 80 dB for extremely hard limiting with good impulse noise rejection. A broadband Foster-Seeley discriminator is used as the FM demodulator, and output of the detector is fed to a buffer stage for isolation from variations in load impedance.

The phase-locked loop stereo decoder IC incorporates two special new systems: the automatic variable separation control circuit mentioned earlier and tri-level digital waveform generation which helps to eliminate interference from SCA signals and from the sidebands of adjacent channel FM signals. Following

the de-emphasis switches, an electronically switched filter circuit is used to reduce out-of-phase noise when receiving weak signal stereo. The filter is actually a twin-T bandpass that blends high and low frequencies, but leaves separation unaffected at mid-frequencies for improved stereo imaging when the filter is required. LC notch filters further reject any residual 19 kHz or 38 kHz sub-carrier output products. A separate headphone amplifier, capable of driving low impedance phones, also serves as the main output amplifier.

Tuning, Scanning and Control Circuitry

A detailed explanation of the touch sensor, preset scanning, control logic, scan circuit and lock circuit, as well as the frequency counter and power supply circuitry is provided in the excellently written owner's manual supplied with the MR 80, and full schematic diagrams are also included, for the benefit of the technically oriented user or for possible servicing needs. The descriptions of the remaining non-RF/IF related circuits are too lengthy for even an abbreviated treatment here, but we cannot leave this subject without providing a brief explanation of the unusual "lock" circuitry designed into this unusual tuner. This new circuit will be correctly tuned even if the station (or, more likely, the cable company) is not on its correct frequency. Two operational amplifiers are used. A deviation signal from the detector is fed to the first amplifier, which produces an output voltage proportional to the logarithm of the DC component in the detector output. A second amplifier, connected as a switched gain low-pass filter, removes any audio signals present. The filter output, which is a correction voltage, is fed into a scaling circuit that compensates for the tuning diodes' non linear frequency to voltage response. Both amplifiers operate with more than 50 dB of gain at DC. So, with a closed loop gain of more than 100 dB, tuning error (when locked) is less than 1 kHz at 100 MHz. This error is less than that obtained with most frequency synthesized circuits and provides the additional benefit of correct tuning even if the station or cable signal is not on proper frequency.

Since this circuit will "track" a station even if it drifts by more than 1 MHz in either direction, the user must be able to defeat the lock easily. The touch sensor switching arrangement on the manual tuning knob takes care of this and, to prevent the tuner from locking onto a strong signal next to a weak signal, a circuit is used to sense strong adjacent channel signals and to inhibit the lock circuit in such circumstances. The lock on/off switch on the top surface of the unit, incidentally, will cancel the lock only insofar as the manual tuning knob is concerned. The lock circuit continues to work for all the preset signals and for the scan circuits.

Laboratory Measurements

The multi-purpose graph of Fig. 3 shows the mono and stereo quieting and distortion (at 1 kHz) characteristics of the MR 80 tuner with the selector switch set for "normal" (normal) selectivity. Usable sensitivity in mono measured 12.0 dBf (2.2 uV) while for stereo, the usable sensitivity was a very low 20 dBf (5.5 uV). The 50 dB quieting point was reached

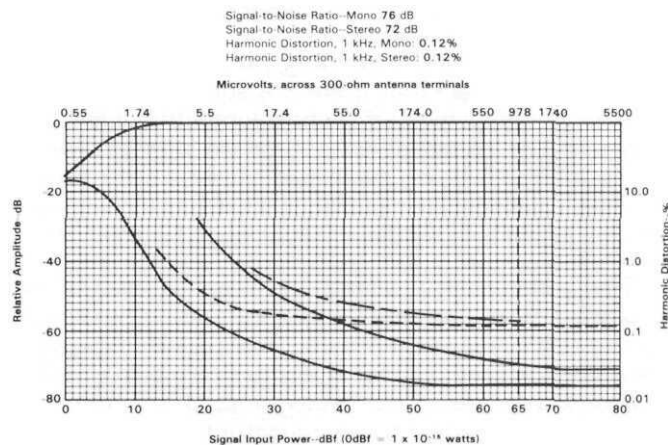

Fig. 3 Mono and stereo quieting and distortion characteristics, FM section.

with input signals of 3.5 uV (16 dBf) in mono and 30 dBf (17.4 uV) in stereo, the stereo result being about the lowest we have ever measured for any stereo FM tuner. At 65 dBf of input signal strength, signal-to-noise ratio measured 76 dB in mono (as opposed to 75 dB claimed by McIntosh) and 71 dB in stereo. Distortion at that strong signal level was the same in mono and stereo, a low 0.1% for 1 kHz signal.

Distortion (harmonic) versus modulation frequencies, for both mono and stereo operation of the tuner, were with selectivity set to the normal or "narrow" position. We measured specific values of 0.12% at 100 Hz for mono, and 0.15% for that frequency in stereo. At 3 kHz, mono distortion was a bit higher than that measured in stereo; 0.18% as against 0.13% but at the highest required test frequency of 6 kHz, stereo THD came close to the 0.2% limit while mono distortion was again a low 0.1%.

We should point out that when the "super narrow" selectivity setting is used, distortion does rise rather significantly, approaching the 1.0% mark, but this is a tradeoff that was most deliberately sought by McIntosh Laboratory's designers. There is just no other way to achieve adjacent channel selectivity of 60 dB without increasing distortion in the stereo mode where sidebands of high frequency modulating signals extend well beyond the single channel width of 100 kHz to either side of center carrier frequency. What is remarkable, in fact, is that McIntosh was able to achieve this sort of adjacent channel selectivity and still keep the distortion level in stereo under 1.0%! It should be noted, incidentally, that noise performance, or signal-to-noise ratios remain essentially the same in the "super narrow" setting as they were in the narrow or normal selectivity mode.

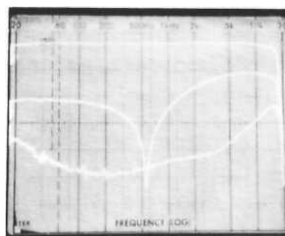

Fig. 4 Frequency response and separation, McIntosh MR 80 with selectivity switch in "Narrow" (normal) position.

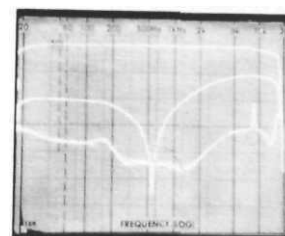

Fig. 5 - Frequency response and separation, McIntosh MR 80, with selectivity switch in "Super Narrow" position.

The spectrum analyzer plots of Fig. 4 illustrates frequency response and separation characteristics of the tuner measured with selectivity set to the "narrow" or normal position. We measured a separation of 50.5 dB at 1 kHz, 48 dB at 100 Hz and 35 dB at 1 0 kHz. The lower trace in the 'scope photo shows the cross-talk in the unmodulated channel. The center trace shows what happens when the multiplex filter circuit is introduced. While separation at the frequency extremes diminishes, notice that at mid-frequencies it is actually greater than it was without the filter over a narrow region of frequencies around the 500 Hz mark.

As might be expected, when selectivity is switched to the "super narrow" mode, separation suffers somewhat, as illustrated in the 'scope photo of Fig. 5. In addition, we note the appearance of some beats at around 9 kHz and at 1 9 kHz in the unmodulated channel output. Again, these are some of the tradeoffs that must be made to obtain the kind of adjacent channel selectivity of which the MR 80 is capable. And that kind of selectivity can only be appreciated by the listener who, having been unable to receive a preferred station because of strong local station interference, suddenly hears the desired signal with absolutely no interference.

In Fig. 6 we have changed the sweep mode of our spectrum analyzer so that it is linear (in previous 'scope photos it was logarithmic as indicated by the frequency notations at the top of the display), and printed frequency notations should now be ignored. The sweep is from 0 Hz to 50 kHz, at 5 kHz per division. The tall spike at the left is the 5 kHz output from the modulated channel. Contained within that spike is the opposite (unmodulated) output from the other channel, while to the right of these are the cross-talk products at harmonics of 5 kHz as well as any residual 1 9 kHz and 38 kHz sub-carrier output products, all of which are about 60 dB or more below the level of 100% modulation.

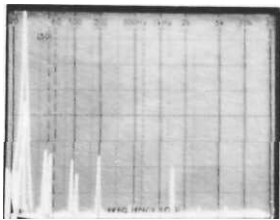

Fig. 6 - Crosstalk components, 5kHz. McIntosh MR 80

Capture ratio measured exactly 1.5 dB as claimed, while image rejection was in excess of the 90 dB claimed at a limit specification. We were unable to measure alternate channel selectivity in the super narrow mode (our equipment can only read reliably to 100 dB) but were able to confirm all other selectivity readings claimed by McIntosh in both the narrow and super-narrow modes of the I-F system.

Summary and Listening Tests

Since our own local distribution of FM stations was such that we did not run into adjacent channel problems if we used a good directional antenna in our listening tests, these tests were divided into two separate parts. First, we did some off-air testing and found that the MR 80 picked up more usable signals than any tuner we have tested over the last three years. The automatic blend filter action and the

variable separation (which occurs automatically) resulted in stereo reception of weak signals that was completely acceptable from a noise point of view but that would have been too noisy for pleasurable listening with other tuners we have tested in recent months. The "lock" circuit always yielded optimum tuning point, as evidenced by a complete absence of audible distortion. In short, as we said at the outset, the MR 80 is designed to cope with the real world of broadcasting.

As proof that it could respond well to the world of the laboratory and in order to determine just how selective the "Super Narrow" I-F setting was, we conducted closed circuit experiments as well. We used a sound Technology Model 1100A Signal Conditioner to modulate our primary Sound Technology Model 1000A stereo signal generator. The Model 1100A provides for direct tape or disc program inputs to the signal generator and also supplies required pre-emphasis. With this arrangement, we were able to transmit some of our favorite disc and tape program material both by direct cable hookup to the MR 80 and by low-power radiation over a distance of several yards. The experiments involved received signal strengths ranging from around 50 uV (39.2 dBf) to over 100,000 uV (105.2 dBf).

Dynamic range capability of the tuner, when reproducing such non-compressed program source material was fully up to the task. With stronger signal strengths, we were literally unable to distinguish between direct playback of the source material and playback through the elaborate "closed circuit" hookup.

To be sure, when listening to off-the-air programs, sound quality was, in almost all cases, governed by the less than perfect transmission and studio practices of most of our locally received FM stations. But quieting, selectivity and capture ratio were deemed to be superior even under these circumstances, since these parameters are not a function of audio quality but of RF and IF section design which, in the case of the MR 80, are superb. One application that may come to mind for this not inexpensive tuner is as a receiver for FM wireless microphone transmitters used in theatrical work. Since even the best of these wireless mics tends to drift over a period of time, the locking and tracking circuitry of the MR 80 would be an ideal tuning arrangement for such microphones. While we have not had experience in our area with cable FM, we have been told that in some instances, frequency accuracy and stability in such cable FM operations is also less than ideal. In addition to its many other virtues, the MR 80 might well provide the solution to steady tuning here as well.

COMPACT, FLEXIBLE - MASTER CONTROL WITH SUPERIOR AM/FM TUNING

THE MCINTOSH MX 117

AM-FM STEREO TUNER-PREAMPLIFIER

Match the McIntosh Stereo Tuner-Preamplifier with the McIntosh power amplifier that satisfies your room and musical requirements. Advanced cir-

cuits and performance features make the McIntosh MX 117 ideal and especially convenient solution for discriminating stereo listeners.



FM AFL AUTOMATIC FREQUENCY LOCK

Automatic Frequency Lock is a patented McIntosh circuit that activates when the center frequency of an FM station is tuned. A varactor diode accurately tunes to the precise center of the station. When the vertical LED indicator lights, the AFL circuit is in operation and the tuner stays locked to the center of the station tuned. There will be no drift, insuring minimum distortion and best overall FM performance.

ELECTRONIC FET ANALOG INPUT SWITCHING

All critical input switching is done electronically using field effect transistor analog switches. The front panel selector controls DC voltages which turn the FET analog switches on or off. Since the FET analog switches are located near the input jacks, potential for noise pickup is reduced.

HEADPHONE—OUTPUT AMPLIFIER

The built-in headphone amplifier has less than 0.02% harmonic distortion. It is capable of driving a pair of dynamic headphones. Because of its extremely low distortion and power capability, it is also the main preamplifier output.

THREE BAND TONE SHAPING CONTROLS

Three separate controls allow response of musical information to be adjusted with far more flexibility than with conventional tone controls. The center frequencies of the controls are 30 Hz, 750 Hz

and 10 kHz, ± 12 dB of control capability. Use of the program equalizer controls does not affect the low noise, low distortion performance of the tuner-preamplifier. When the equalizer controls are in their center detent or flat position, their action is neutral and response of the tuner-preamplifier is absolutely flat.

TRUE LOUDNESS COMPENSATION

The MX 117 loudness control is continuously variable with constant midrange gain. It is an active circuit that operates independently of the volume control. The contour is accurately modeled after the Fletcher Munson family of "Equal Loudness" Curves. Use of this control restores proper perceived frequency response at even the softest listening levels.

HIGH ACCURACY TRACKING VOLUME CONTROL

The volume control is a step attenuator which has tracking accuracy within 1 dB throughout its entire range. Such extremely accurate matching is achieved through electronically controlled trimming of the resistance material deposited on pairs of miniature printed circuits. Tracking accuracy and quiet performance are permanently maintained. Use does not affect performance as in ordinary volume controls.

AUTOMATIC STEREO NOISE SUPPRESSION

A new third generation phase locked loop stereo decoder incorporates a unique variable stereo

separation—noise reduction control circuit. When listening to weak or distant FM stations, optimum stereo separation and signal to noise ratio is automatically provided.

UNIQUE AM TUNER SECTION

The AM circuit in the MX 117 is unique in design for a superheterodyne tuner. The AM RF amplifier circuit has constant selectivity, constant sensitivity and high image rejection across the complete AM band. In addition there is no loss of audio frequency response at the low end of the band. It is the only AM circuit that has all these features simultaneously. These advanced AM performance characteristics bring about a re-discovery of AM listening.

PERFORMANCE LIMITS and RATINGS PREAMPLIFIER SECTION

FREQUENCY RESPONSE:

+ 0 - 0.5 db from 20 Hz to 20 kHz

RATED OUTPUT LEVELS:

Main Out	2.5V
Line Out	1.25V
Headphone	750mV
Tape Out	250mV

DISTORTION:

0.02% maximum at 2.5V output from 20 Hz to 20 kHz

INPUT SENSITIVITY AND GAIN:

Input to Main Out	
Phono 1 and 2	2.2mV in for 2.5V out (61.1 dB gain at 1 kHz)
Aux, Tape 1 and 2	250mV in for 2.5V out (20 dB gain at 1 kHz)
Input to Line Out	
Phono 1 and 2	2.2mV in for 1.25V out (55 dB gain at 1 kHz)
Aux, Tape 1 and 2	250mV in for 1.25V out (14 dB gain at 1 kHz)
Input to Headphone Out	
Phono 1 and 2	2.2mV in for 750mV out (50.7 dB gain at 1 kHz)
Aux, Tape 1 and 2	250mV in for 750mV out (9.5 dB gain at 1 kHz)
Input to Tape Out	
Phono 1 and 2	2.2mV in for 250mV out (41.1 dB gain at 1 kHz)
Aux, Tape 1 and 2	250mV in for 250mV out (0 dB gain at 1 kHz)

SIGNAL TO NOISE:

Phono 1 and 2	-90 dB IHF A-weighted, below 10mV input -80 dB unweighted, below 10mV input
Aux, Tape 1 and 2	- 100 dB IHF A-weighted, below 250mV input -90 dB unweighted, below 250mV input

INPUT IMPEDANCE:

Phono 1 and 2	47kW and 50pF
Aux, Tape 1 and 2	47kW

OUTPUT IMPEDANCE:

Main Out	less than 100S7 (to operate into 5kW or greater)
----------	--

Line Out	600(2 (to operate into a 600W line)
Headphone	8W
Tape Out	less than 200W (to operate into 5kW or greater)

EQUALIZER CONTROL RESPONSE:

Center Frequencies	30, 750, and 10 kHz
Boost and Cut	±12 dB

AM SECTION

SENSITIVITY:

75mV IHF with external antenna

SIGNAL TO NOISE RATIO:

45 dB minimum IHF or 55 dB at 100% modulation

FREQUENCY RESPONSE:

+ 0 -6 dB from 20 Hz to 3500 Hz

HARMONIC DISTORTION:

0.8% maximum at 30% modulation

ADJACENT CHANNEL SENSITIVITY:

30 dB minimum IHF

IMAGE REJECTION:

65 dB minimum from 540 kHz to 1600 kHz

FM SECTION

USABLE SENSITIVITY:

2mV(11.2dBf) IHF

QUIETING SENSITIVITY:

5mV (19.1dBf) IHF -50 dB (Mono)
50mV (39.5dBf) IHF -50 dB (Stereo)

SIGNAL TO NOISE RATIO:

70 dB IHF minimum both Mono and Stereo

HARMONIC DISTORTION:

0.18% (Mono) IHF maximum
0.38% (Stereo) IHF maximum

ALTERNATE CHANNEL SELECTIVITY:

75 dB IHF minimum

IMAGE REJECTION:

100 dB IHF minimum

STEREO SEPARATION:

45 dB minimum at 1 kHz

GENERAL INFORMATION

POWER REQUIREMENT:

120 Volts 50/60 Hz, 45 Watts

SEMI CONDUCTOR COMPLEMENT:

24 Bipolar Transistors
18 Field Effect Transistors
62 Diodes
24 Integrated Circuits

MECHANICAL INFORMATION

SIZE:

Front panel measures 16 inches wide (40.6 cm) by 5 7/16 inches high (13.8 cm). Chassis measures 14 3/4 inches wide (37.5 cm) by 4 13/16 inches high (12.2 cm) by 13 inches deep (33 cm), including connectors. Knob clearance required is 1 1/4 inches (3.2 cm) in front of mounting panel.

FINISH:

Front panel is anodized gold and black with special gold/teal nomenclature illumination. Chassis is black.

MOUNTING:

McIntosh developed professional PANLOC.

WEIGHT:

24 pounds (10.9 kg) net, 36 pounds (16.3 kg) in shipping carton.

PRODUCT ANALYSIS

THE MCINTOSH MX 117 AM/FM TUNER-PREAMPLIFIER

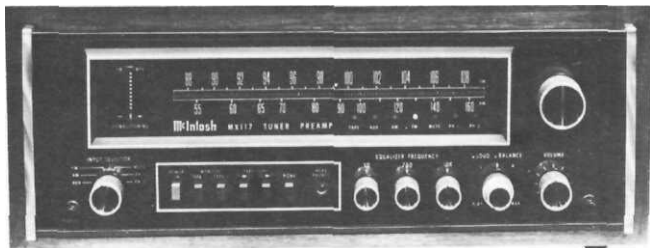

Fig. 1 —Front panel view of
McIntosh MX 117 Tuner-Preamplifier

MANUFACTURER'S PUBLISHED SPECIFICATIONS:

FM Tuner Section:

Usable Sensitivity: 11.2 dBf (2.0 uV/300 ohms) **50 dB Quieting Sensitivity:** 19.1 dBf, mono; 39.5 dBf, stereo. **Signal-to-Noise Ratio:** 70 dB minimum, both mono and stereo. **Harmonic Distortion:** 0.18% mono, 0.38% stereo, maximum. **Alternate Channel Selectivity:** 78 dB minimum. **Image Rejection:** 100 dB minimum. **Stereo Separation:** 45 dB minimum at 1 kHz.

AM Tuner Section:

Sensitivity: 75 uV (external antenna) **Signal-to-Noise Ratio:** 45 dB min IHF or 55 dB @ 100% modulation. **Adjacent Channel Sensitivity:** 30 dB Minimum. **Image Rejection:** 65 dB minimum from 540 kHz to 1600 kHz. **Frequency Response:** +0, -6 dB, from 20 Hz to 3500 Hz.

Preamplifier Section:

Frequency Response: +0, -0.5 dB, 20 Hz to 20 kHz. **Rated Outputs:** Main: 2.5 V; Line: 1.25 V; Headphone: 750 mV; Tape: 250 mV. **Distortion:** 0.02% max. @ 2.5 V output from 20 Hz to 20 kHz. **Input Sensitivity for 2.5 V at Main Out:** (Phono) 2.2 mV; (High Level) 250 mV. **Signal-to-Noise:** (Phono, re: 10 mV in) 90 dB "A" wt'd, 80 dB unwt'd. (High Level, re: 250 mV in): 100 dB wt'd; 90 dB unwt'd. **Input Impedance:** (Phono 1 & 2): 47 K ohm & 50 pF. High Level: 47 K ohm. **Output Impedance:** (Main): Less than 100 ohms; (Line): 600 ohms; (Phone): 8 ohms; (Tape): Less than 200 ohms. **Equalizer Control Response:** ± 1.2 dB at 30 Hz, 750 Hz and 10 kHz.

GENERAL SPECIFICATIONS:

Dimensions: 16" wide x 5-7/16" high (panel). **Chassis:** 13" deep. Knob clearance in front of panel: 1 1/4". Net Weight: 24 lbs.

McIntosh Laboratory Inc. remains one of the few companies that continues to offer a high fidelity component which incorporates both FM/AM tuner circuitry and preamplifier-control circuits. It strikes us that for those audio enthusiasts who do want to include radio (and particularly high-fidelity stereo FM radio) as a program source in their audio systems, this combination, on a single chassis, makes a great deal of sense; so much so, in fact, that we have always wondered why other manufacturers have not offered this type of component in greater numbers. After all, it permits the user to choose any power amplifier he or she requires, allows for the incorporation of two turntables as well as two tape decks, offers the versatility of a separate preamp-control unit while at the same time incorporating a top-performing stereo FM/AM tuner.

Front Panel Layout

The MX 117 has the unmistakable McIntosh front panel look, with its anodized gold and black finish, its gold/teal illuminated nomenclature and its exclusive PANLOC mounting system which has become a tradition of Mac equipment. A large, well-illuminated cut-out area of the panel contains the calibrated AM and FM dial scales, and evenly spaced "logging scale" (calibrated linearly in 0.1 increments from 0 to 10), seven small indicator lights (which denote program source selected as well as selection of interstation muting during FM listening) and a fourteen-LED solid-state tuning indicator system, consisting of ten small dots arranged in a vertical row, a small bar which illuminates to denote stereo signal reception and three bars which tell you whether you are tuned above, below, or precisely "on center" frequency when listening to FM.

A conventional, flywheel-coupled tuning knob is positioned to the right of the dial area. All remaining front panel controls are neatly arranged along the lower section of the panel. These include a six-position, program source selector switch at the lower left (AUX, AM, FM, MUTE{FM}, PH{ono}1 and PH{ono}2), three tone controls to the right of center (McIntosh prefers to call them equalizer controls, since they do divide the audio spectrum into three parts, as opposed to simple bass and treble tone controls which usually control wider swaths of frequencies), a dual-concentric balance and loudness control and a master volume control at the lower right. Six push-button switches plus a stereo headphone jack are located to the left of center of the panel. A light-colored button serves as the power on/off switch while the contrasting dark-shaded buttons handle such functions as TAPE 1 or TAPE 2 monitoring, Tape Copying from either connected tape deck to another, and stereo/mono selection. The loudness control arrangement found on the MX 117 is different from any that we have previously encountered and we shall have more to say about its action presently.

Rear Panel Controls

Stereo pairs of input jacks and a chassis ground terminal are located at the extreme right of the rear panel of the MX 117. Inboard of these are two pairs of "Main" output jacks, line out jacks (designed to operate into 600-ohm loads), the tape-out jacks (for connection to up to two tape decks) and vertical and horizontal oscilloscope output jacks which may be connected to McIntosh's "Maximum Performance Indicator" or to any oscilloscope for observation of multipath phenomena during orientation and optimization of an FM antenna. A pivotable AM loopstick ferrite antenna is located at mid-panel, and next to it is an FM preselector switch which introduces additional tuned-circuit filtering for additional RF selectivity in the event of strong-signal overload conditions. Normally, this switch is left in the "out" position.

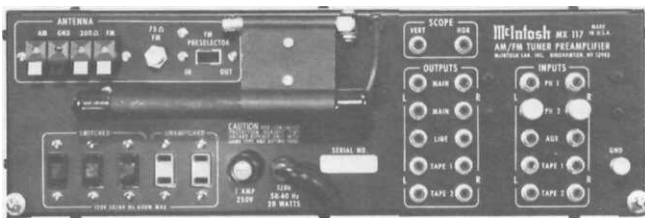

Fig. 2—Rear panel view of McIntosh MX 117 Tuner-Preamplifier

External AM, ground, and 300-ohm FM antenna connection terminals of the "push to insert wire" spring-loaded type are at the upper right of the rear panel, while alongside is a standard coaxial connector for use with 75-ohm transmission lines. Three switched and two unswitched convenience AC outlets complete the rear panel layout. Up to 600 watts of power can be drawn from all of these AC receptacles, combined.

Circuit Highlights

The FM front end employs five sections of an 8-section variable capacitor (four, when the preselector switch is in the "out" position). As with most of the switch functions of the MX 117, even the preselector switching is accomplished electronically, with a DC voltage controlling PIN semiconductor diodes which do the actual switching. Front panel selector switching, for example, simply switches control voltages which turn FET analog switches on or off. Since the actual switches are located near the input jacks, pickup noise and high-frequency losses are minimized compared with conventional mechanical switching arrangements.

A double-tuned MOS-FET RF Amplifier and a balanced MOS-FET mixer are used in the FM front end. A MOS-FET buffer amplifier is used between the local oscillator and the mixer. The oscillator is fine tuned by a varactor diode operated by a correction voltage which is derived from a patented McIntosh

circuit call Automatic Frequency Lock (AFL) which turns on a "lock" voltage when perfectly centered tuning has been reached.

The FM I-F section uses five integrated circuit amplifiers and four piezo-electric filters, for a total gain of 140 dB. A full Foster-Seeley discriminator (as opposed to the more common Ratio Detector) discriminator completes the I-F system. The composite demodulated signal feeds the stereo FM multiplex section, the heart of which is a new type of phase-locked-loop stereo decoder IC. This IC incorporates an automatic variable separation control (to reduce background noise during weak-signal stereo reception), and tri-level digital waveform generation which eliminates interference from SCA signals and from the sideband of adjacent channel FM signals. 19 kHz and 38 kHz carrier suppression circuits are used to attenuate any residual carrier components following multiplex decoding. The FM muting circuit employed in the MX 117 operates by detecting ultrasonic noise and by sensing correct center-tuning of the detector circuit. Muting of the audio signal is done with a positive acting FET switching circuit.

The AM tuner section employs a three-section tuning capacitor and a special AM-RF amplifier which maintains constant selectivity, constant sensitivity and high image rejection across the entire AM band. An autodyne circuit is used for the AM mixer and two double-tuned transformers are used in the AM-IF section. A 10 kHz "whistle filter" is included in the AM tuner section, as is a two-section AVC filter for lower distortion at bass frequencies.

The phono preamplifier-equalizer section uses an IC operational amplifier whose differential input stage has been optimized for low noise and low distortion. The feedback network which also provides RIAA equalization employs 1% metal film resistors and 5% polyfilm capacitors. The gain of this preamp section is just over 41 dB. As for the unusual loudness control arrangement referred to earlier, it uses the same sort of IC operational amp used in the phono preamp stages. Two feedback loops are employed: one flat, the other conforming to the Fletcher-Munson equal loudness contours. A potentiometer (the front panel "LOUDNESS" control) placed between these loops makes it possible to select any curve from flat response to full loudness compensation. Once the contour is set by the user, it remains fixed and independent of the position of the master volume control. The equalizer-amplifier also uses a low-noise operational amplifier. Three other op-amps are arranged in the circuit equivalents of three tuned circuits; each resonant at one of the three equalizer center frequencies.

The output amplifier of the MX 117 is a push-pull complementary class AB circuit which uses a signal-inverting differential stage at its input. The amplifier drives the main and line outputs as well as the head-

phone jack. A turn-on delay circuit using a light-emitting diode/light dependent resistor network that transmits no signal for two seconds after power is applied also operates to turn off signals almost instantly when power is turned off. This arrangement serves to keep turn-on and turn-offs of the tuner-pre-amplifier transient-free.

The power transformer of the MX 1 1 7 is triple shielded (copper strap, silicon steel strap and steel outer shell) for minimum hum and radiation. A full wave bridge rectifier with 3300 mfd filter capacitors provide the DC voltages which are applied to positive and negative supply regulators. IC regulators supply the dual-polarity 18 volts of DC needed for the low-level amplifier stages.

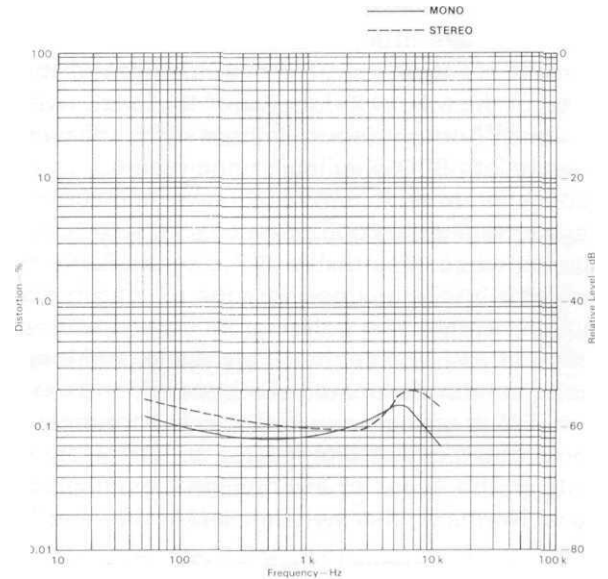

Fig. 5—Harmonic distortion vs. frequency, McIntosh MX 1 1 7 Tuner-Preamp (FM tuner section)

Distortion, too, was considerably better than claimed by McIntosh. Under strong-signal conditions (standard test conditions at 65 dBf), harmonic distortion for a 1 kHz signal at 100% modulation measured 0.086% in mono and almost as low, 0.10% in stereo. Nor was this low level of distortion limited to mid-frequencies as can be seen by examining Fig. 5, which plots distortion as a function of modulating frequencies.

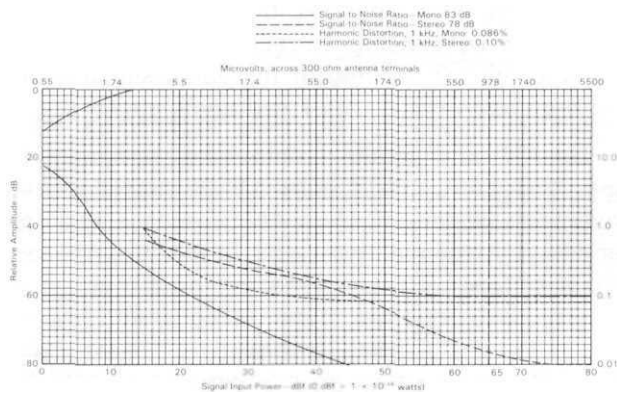

Fig. 4—Mono and stereo quieting and distortion characteristics, FM section.

FM Performance Measurements

Figure 4 is a multiple plot of mono and stereo quieting characteristics and mono and stereo total harmonic distortion characteristics (at 1 kHz) of the FM tuner section of the MX 1 1 7. Usable sensitivity in mono measured 10.8 dBf (1.9 uV, 300 ohms) or a bit better than claimed, while in stereo, usable sensitivity was determined by the stereo switching threshold, which occurred at 1.5 dBf (3.1 uV). The more important 50 dB quieting point was reached in mono at a very low signal strength of only 1.2 dBf (2.2 uV), while in the stereo mode, that degree of quieting was reached at a signal input level of only 27.5 dBf (13.0 uV), about as low as we have measured for any stereo FM tuner. McIntosh, as usual, seems to insist upon publishing ultra-conservative specification. In the case of the MX 1 1 7 they claimed only a minimum of 70 dB of signal-to-noise in mono and stereo FM. In fact, our sample measured S/N of 83 dB in mono! Even in the stereo mode, where S/N is generally poorer, we still obtained a reading of 78 dB for an input of 65 dBf (approximately 1 000 uV) and, with somewhat stronger signals, the S/N improved even further to 80 dB.

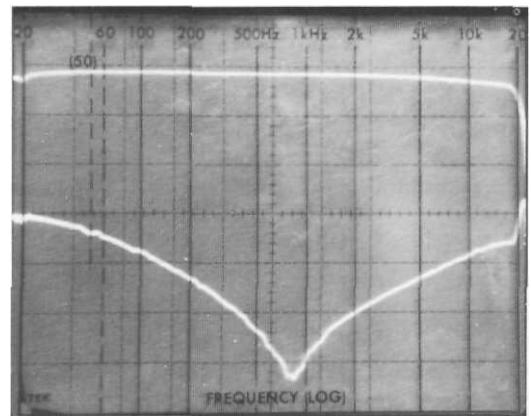

Fig. 6—Frequency response (upper trace) and stereo separation, McIntosh MX 117 Tuner-Preamp

Figure 6 is a 'scope photo of a spectrum analyzer multiple sweep in which the upper trace represents output from the left channel main output with a Left-only signal modulating our FM generator and sweeping from 20 Hz to 20 kHz. The lower trace was obtained by subsequently measuring the output of the Right channel under the same modulation conditions, and is therefore a measure of stereo separation versus frequency. The vertical scale is 10 dB per

division in this and all other 'scope photos. At 1 kHz, separation measured an impressively high 55 dB (as opposed to McIntosh's conservatively guaranteed 45 dB) while at the frequency extremes of 100 Hz and 10 kHz we measured 37 dB and 35 dB respectively. In Fig. 7, the sweep mode was changed, so

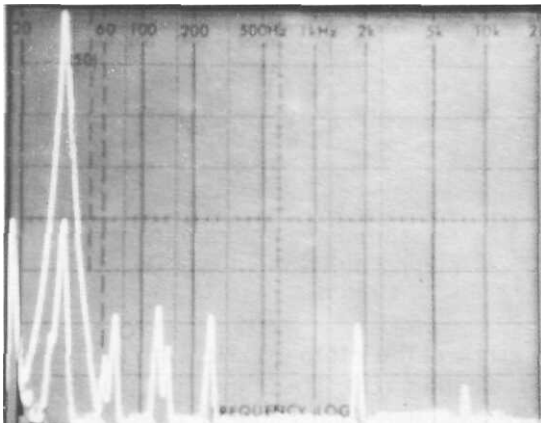

Fig. 7—Crosstalk components, 5 kHz, McIntosh MX 117 Tuner-Preamp

that this time the sweep was linear, from 0 Hz to 50 kHz, with the lightly visible scale corresponding to 5 kHz per horizontal division. The tall spike at left is a 5 kHz output from the modulated channel. Contained within that spike is the representation of the opposite (unmodulated) channel output, while to the right of these are various cross-talk products at harmonics of 5 kHz as well as any residual 19 kHz or 38 kHz sub-carrier output products. All of these extraneous output products were at least 60 dB or better below the desired reference output level. Note, too, that separation at the relatively high 5 kHz frequency was approximately 40 dB (the difference in "height" between the two spikes at 5 kHz—one within the other—at the left of the display). Muting threshold for this FM tuner was set to 17 dBf (3.9 uV), an ideal signal level for this type of muting circuit, since it allows

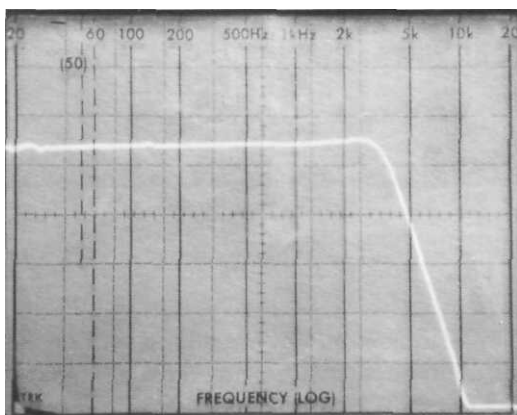

Fig. 8—Frequency response, AM section, McIntosh MX 117 Tuner-Preamp

the listener to enjoy reception of marginally quiet signals while still benefiting from the interstation muting feature. We measured an alternate channel selectivity of 80 dB for this sample. SCA rejection, under conditions of a modulated 67 kHz SCA sub-carrier injected at 10% of total modulation of the main carrier was a very satisfactory 60 dB below reference output level while stereo sub-carrier product rejection was in excess of 65 dB.

While it is not our practice to spend too much time testing the AM sections of AM-FM tuners (most of them are simply so poor in performance that they are not worth bothering about), we do, as a matter of course, measure at least the frequency response of the AM tuner sections. As can be seen in Fig. 8, we were pleasantly surprised to find absolutely flat response down to 20 Hz (most AM tuners tend to roll off bass severely below 50 to 100 Hz or so). And while response to 3.5 kHz may not seem like "hi-fi" reproduction to most listeners, it is actually better than the response obtained from most of the AM sections of combination AM-FM tuners or receivers that we measure in our laboratory.

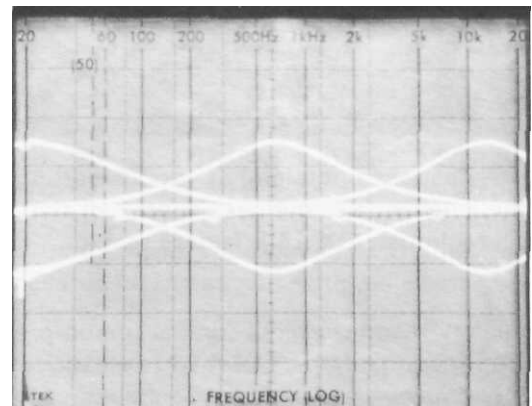

Fig. 9—Range of equalizer controls, McIntosh MX 117 Tuner-Preamp

Preamplifier and Control Section Measurements

McIntosh Laboratory has chosen to publish their specifications relating to the audio portions of the MX 117 in a way that pre-dates the new IHF/EIA Amplifier Standards, whereas in our lab we adhere to the newer standards. Since this would make it difficult to compare published specs with measured results, we decided to make both types of measurements. In that way, those interested in comparing results with those obtained for other products where the IHF/EIA standard was used will be able to do so, while those wishing to compare results with McIntosh published specs can do so as well. IHF/EIA phono input sensitivity measured 0.45 mV. This corresponds to almost exactly 2.2 mV as claimed by McIntosh for the higher 2.5 volt output. As for the high level inputs, 50 mV of signal was required to deliver the

reference 0.5 volts output, and this too corresponds exactly to the 250 mV spec called for by McIntosh for their referenced output level of 2.5 volts.

Figure 9 illustrates the range of control of each of the three equalizer controls provided on the MX 117. The frequencies at which the three equalizer controls are centered make for an extremely versatile range of control. The action of the unique loudness control found in the MX 117 is illustrated in the series of response curves plotted by means of our spectrum analyzer and reproduced in the 'scope photo of Fig. 10. Note that only a moderate amount of treble compensation comes into play as the control is advanced towards more contouring.

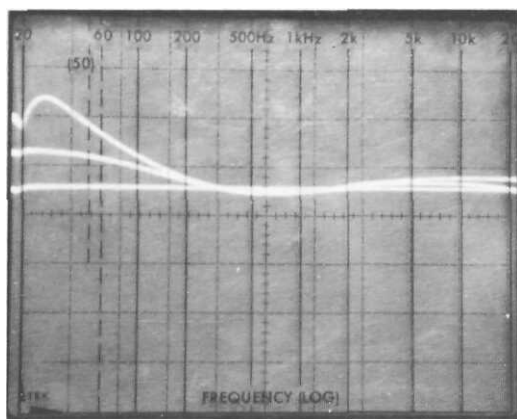

Fig. 10—Response obtained at various settings of the independent loudness control of the McIntosh MX 117 Tuner-Preamp

Frequency response plots for the phono preamp-equalizer section of the MX 117 were accurately plotted using our new Sound Technology 1500A test instrument and an associated video printer. In Fig. 11 we see the familiar RIAA playback curve obtained by feeding a constant amplitude frequency-swept signal into the phono inputs. The plot extends

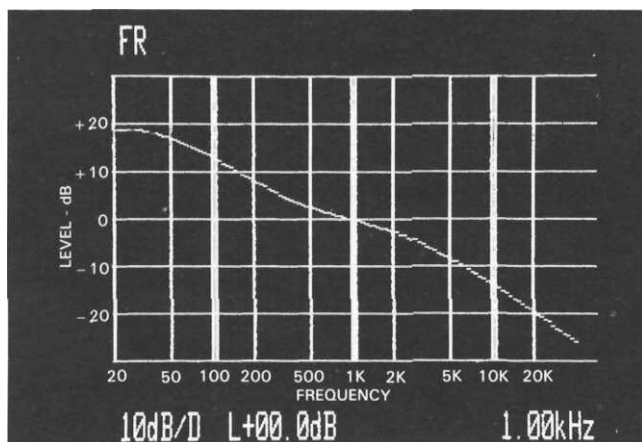

Fig. 11—Phono preamp-equalizer response, McIntosh MX 117 Tuner-Preamp

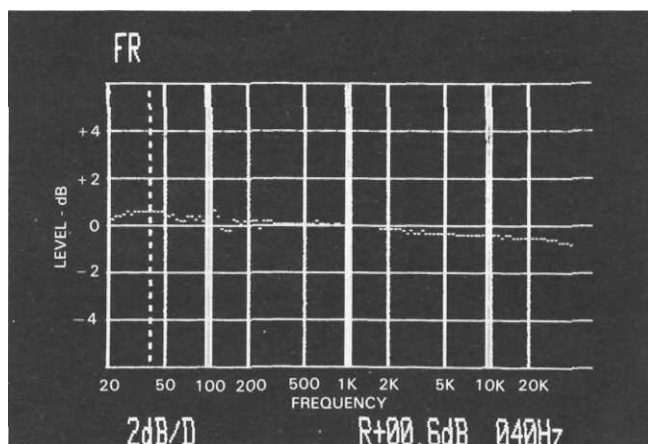

Fig. 12—Expanded-scale phono response, using inverse RIAA input test signal

from 20 Hz at the left to 40 kHz, with double vertical lines indicating 100, 1000 and 10,000 Hz. 0 dB reference has been established at 1 kHz as shown. In Fig. 12 the vertical sensitivity of the plot has been expanded so that it is 2 dB per vertical division (instead of 10, as in the previous display). Also, the signal applied to the phono inputs has not been subjected to inverse RIAA equalization so that, in theory, if perfect RIAA equalization were incorporated in the MX 117, a "straight line" response would be obtained. As you can see, maximum deviation from this ideal was 0.6 dB at 40 Hz (where the dotted line cursor is positioned for a read-out at the lower right of the display) while moving the cursor to the maximum deviation in the high frequency region (Fig. 13), shows a maximum deviation from "absolute RIAA accuracy" of only 0.5 dB at 18.5 kHz.

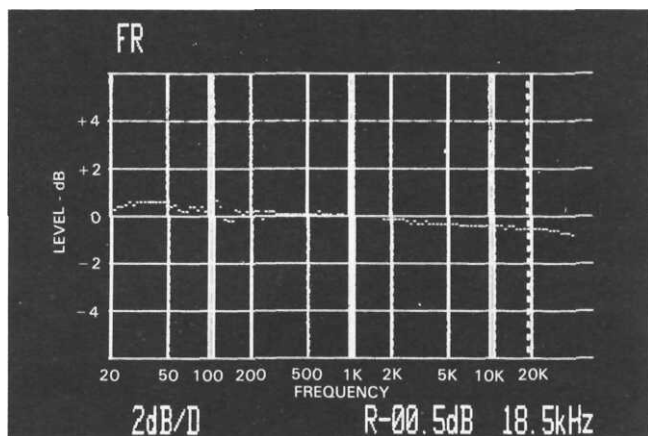

Fig. 13—Same as Fig. 12, except "cursor" has been moved to read relative response at 18.5 kHz

Signal-to-noise ratio of the phono section was first measured in accordance with the IHF/EIA standard, which calls for a 5 mV input at 1 kHz and adjustment of the volume control so as to produce an output of 0.5 volts. Under these conditions, and using an "A-weighting" curve, a reading of 84.4 dB was ob-

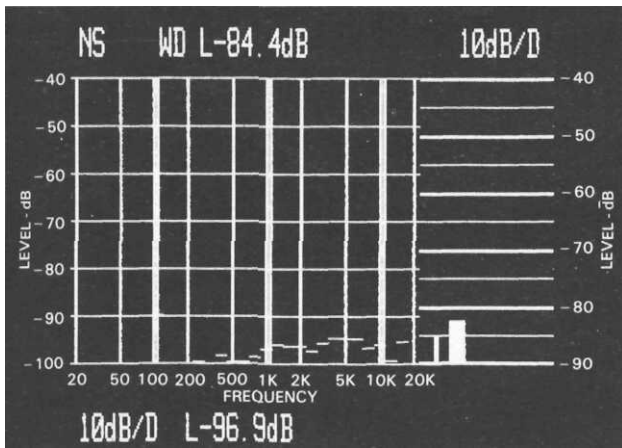

Fig. 14—Phono signal-to-noise plot, referred to 5 mV input, 0.5 volts output

tained. Spectral distribution of the noise, in one-third octave bands, is plotted in the frequency/amplitude grid of Fig. 14. When we adjusted input and output levels to correspond to the measurement method used by McIntosh, (10 millivolts of input), a repeat of the S/N measurement plot as shown in Fig. 15 yielded a ratio of 91.9 dB, fully 2 dB better than claimed.

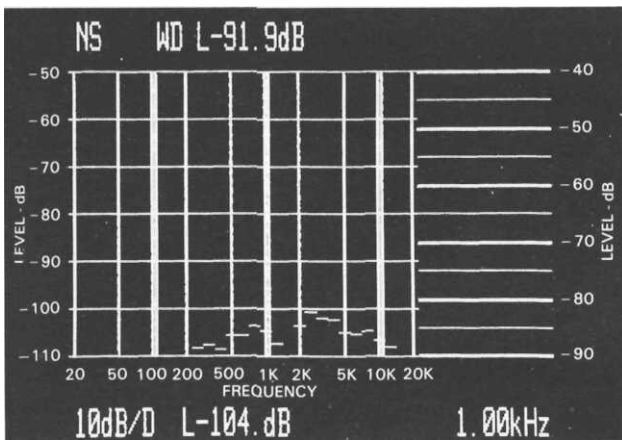

Fig. 15—Same as Fig. 14, but using 10 mV input, per McIntosh specs

Signal-to-noise ratios obtained via the high-level inputs (AUX 1, AUX 2 or Tape) were above 100 dB and beyond the capability of this test instrument to measure.

Distortion of the amplifier section of the MX 117 measured far below the minimum specification supplied by McIntosh. For an input level of 250 mV (high level inputs) and an output of 2.5 volts, THD measured 0.0017% and 0.0018% at 1 kHz for the left and right channel outputs respectively. For a 20 Hz signal input, results were 0.005% and 0.0049%, while for a 20 kHz input signal of the same amplitude, the distortion readings were 0.003% for either channel. Phono overload measured an acceptable

105 mV at 1 kHz. Overall frequency response was down by -1 dB at 14 Hz and 41 kHz, while the -3 dB points were observed as 10 Hz and 78 kHz.

Summary and Listening Tests

As usual, McIntosh has come up with another fine high fidelity component in the MX 117. The design is extremely well balanced, so that all sections of the product seem to work equally well. The FM tuner section was very sensitive. The stations we normally expect to receive with little audible background noise (plus a few we don't often receive in "listenable" fashion) came through nicely and, we should mention, that dial calibration was as close to perfect as any we have seen—from one end of the dial to the other. The AFL circuit, for all its fine "hold" on the stations we tuned to did not prevent us from zeroing in on weak stations that were located very close to stronger ones—a complaint often lodged against less sophisticated forms of AFC circuitry. Stereo separation was excellent and even when we expected to hear background noise when tuning to certain familiar weak stereo signals, the noise was far less obtrusive than expected. This, no doubt, was thanks to the automatic stereo noise suppression circuit with its variable stereo separation circuitry.

The phono preamplifier circuitry produced no audible hum or noise even when reproducing extremely soft passages from records having wide dynamic range. Nor was there any evidence of overload during peak groove excursions in audiophile records which we auditioned on the MX 117. Bass reproduction was tight and completely unmuddied and open. Treble tones were reproduced with no trace of harshness or fuzziness and with excellent transient signal clarity.

To all of these attributes must be added the intangible qualities of durability, care in assembly, and the almost-custom like craftsmanship which distinguishes all McIntosh products from so many others. Most McIntosh equipment owners consider these non-obvious qualities to be worth fully as much, if not more, than the more obvious features found in equipment made by their favorite hi-fi component maker. Under those circumstances, what appears to be a relatively high price for this tuner-pre-amplifier may be a bargain, after all.



THE MAC 4100

A HIGH QUALITY, HIGH POWER AM/FM STEREO RECEIVER

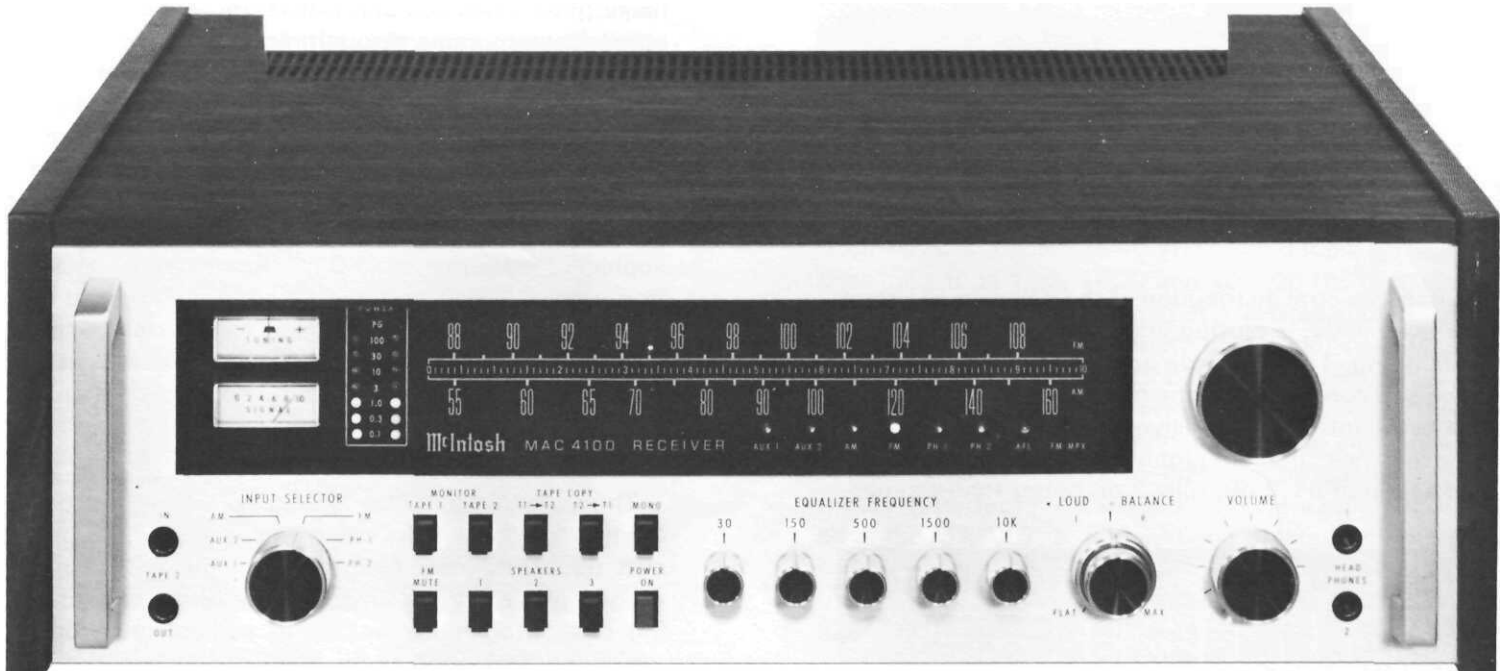

AUTOMATIC POWER TURN ON/TURN OFF

Power to the entire stereo system can be controlled from either the front panel power switch or the turntable's power switch. A current sensing relay connected to the turntable AC power outlets is controlled by the turntable power switch. The relay, in turn controls the AC power to the remainder of the system. Sensitivity of the circuit is adjustable to match the current consumption of your turntable.

POWER GUARD INDICATOR AND PROTECTION CIRCUIT

Loudspeakers are protected from burnout by the Power Guard circuit and also by other circuits that instantaneously disconnect the speakers in the event of the presence of DC on the output. Two power guard indicators indicate when the power amplifier has reached full output. At this point the power guard circuit begins to control amplification dynamically so that you will not hear the harsh distorted sound of square wave clipping. In addition your speakers are protected from burnout.

SPEAKER SWITCHES FOR THREE SETS OF SPEAKERS

Three sets of loudspeakers may be used one at a time, two together, or all three simultaneously.

DUAL TAPE MONITOR AND TAPE COPY SWITCHES

Two tape recorders can record simultaneously from the program being listened to or you may record from one to the other without interfering with the "Listen" program.

FIVE BAND TONE SHAPING CONTROLS IN EITHER THE RECORD OR LISTEN CIRCUITS

Five separate controls permit individual musical spectra shaping to satisfy personal preference or program limitations. There is 12 dB plus or minus control at center frequencies of 30, 150, 1,500 and 10,000 Hz. In the center (detent) position the tone shaping circuits are not active.

ACTIVE LOUDNESS CONTROL

Loudness controls typically are simple, passive circuits connected to a portion of the rotation range of the volume control. As a consequence,

loudness compensation accuracy is dependent on many variables such as speaker efficiency, amplifier gain and differences in input level. The loudness control is continuously variable, operates independently of the volume control, and its contour is accurately modeled after the Fletcher Munson family of "Equal Loudness" curves.

- **HIGH ACCURACY TRACKING VOLUME CONTROL**

The volume control, is a step attenuator which has tracking accuracy within 1 dB throughout its entire range. Such extremely accurate matching is achieved through electronically controlled trimming of the resistance material deposited on pairs of printed circuits. Tracking accuracy and quiet performance are permanently maintained. Use does not affect performance as in ordinary volume controls.

- **TURN-ON TRANSIENT ELIMINATION CIRCUITS**

Speaker outputs are connected only after power supplies and circuits have stabilized eliminating turn on thumps or clicks.

PERFORMANCE LIMITS and RATINGS

POWER OUTPUT:

100 watts minimum sine wave continuous average power output, per channel, both channels operating into 4ohms 20Hz to 20kHz, with no more than 0.05% total harmonic distortion

75 watts minimum sine wave continuous average power output, per channel, both channels operating into 8 ohms 20Hz to 20kHz, with no more than 0.05% total harmonic distortion.

OUTPUT LOAD IMPEDANCE:

4 ohms, 8 ohms

RATED POWER BAND:

20Hz to 20kHz

TOTAL HARMONIC DISTORTION:

0.05% maximum at any power level from 250 milliwatts to rated power per channel, 20Hz to 20,000Hz, both channels operating

FREQUENCY RESPONSE:

20Hz to 20kHz + 0, -0.5dB at rated power

INTERMODULATION DISTORTION:

0.05% maximum at any power level from 250 milliwatts to rated power per channel both channels operating for any combination of frequencies 20Hz to 20,000Hz

NOISE AND HUM:

Power Amplifier: 100dB IHFA, 95dB unweighted, below rated output. Tape and Aux Input: 95dB IHFA, 90dB unweighted below rated output. Phono Input: 90dB IHFA, 80dB unweighted, below 10mV input

DAMPING FACTOR:

Greater than 30

INPUT SENSITIVITY AND IMPEDANCE:

Power Amplifier: 2.5 volts, 22,000ohms; Tape, Auxiliary: 250 millivolts, 100,000ohms; Phono: 2 millivolts, 47,000ohms, 87pF

TAPE OUTPUT LEVEL:

Tuner: 1.0 volts at 100% modulation [FM]; Tape:

250 millivolts with rated input; Phono: 250 millivolts with rated input

PROGRAM EQUALIZER:

± 12dB at 30,150,500,1500,and 10,000Hz

FM

SENSITIVITY:

2mV[11.2dB] IHF minimum

SIGNAL TO NOISE RATIO:

70dB IHF minimum

HARMONIC DISTORTION:

Mono: 0.18% IHF maximum Stereo: 0.38% IHF Maximum

FREQUENCY RESPONSE:

20Hz to 15kHz +0, -1dB

CAPTURE RATIO:

1.8dB

SELECTIVITY:

75dB IHF minimum

SPURIOUS REJECTION:

90dB IHF minimum

IMAGE REJECTION:

80dB IHF minimum

STEREO SEPARATION:

45dB minimum at 1kHz

SCA REJECTION:

60dB minimum

AM

SENSITIVITY:

75mV IHF [External antenna]

SIGNAL TO NOISE RATIO:

45dB minimum IHF, 55dB at 100% modulation

HARMONIC DISTORTION:

0.8% maximum at 30% modulation

FREQUENCY RESPONSE:

6 dB down at 3500 Hz

ADJACENT CHANNEL SELECTIVITY:

30dB minimum IHF

IMAGE REJECTION:

65dB minimum, 540kHz to 1600kHz

GENERAL INFORMATION

SEMICONDUCTOR COMPLEMENT:

45 Transistors, 31 Integrated Circuits, 62 Diodes, 1 Silicon Controlled Rectifier

POWER REQUIREMENTS:

120 Volts, 50/60 Hz, 0.6 to 4 amperes (72 to 480 watts)

MECHANICAL INFORMATION

SIZE:

IN CABINET: 18-5/8 inches (47.3cm) wide, 6-1/2 inches (16.5cm) high, 15-1/2 inches (39.4cm) deep.

WITHOUT CABINET: Front panel measures 17-9/16 inches (44.6cm) wide by 5-1/4 inches (13.3cm) high. Chassis measures 17-1/8 inches (43.5cm) wide by 4-15/16 inches (12.5cm) high by 13-1/2 inches (34.3cm) deep. Knob and handle clearance required is 1-1/4 inches (3.2cm) in front of the mounting surface.

FINISH:

Front panel is clear anodized to produce a brushed satin/silver finish with black trim. Cabinet is walnut grained vinyl

WEIGHT:

42 pounds (19 kg) net, 56 pounds (25.4 kg) in shipping carton

New Equipment Reports

A CONSUMER'S GUIDE

Preparation supervised by
Robert Long, Harold A. Rodgers,
and Edward J. Foster
Laboratory data (unless otherwise noted)
supplied by CBS Technology Center

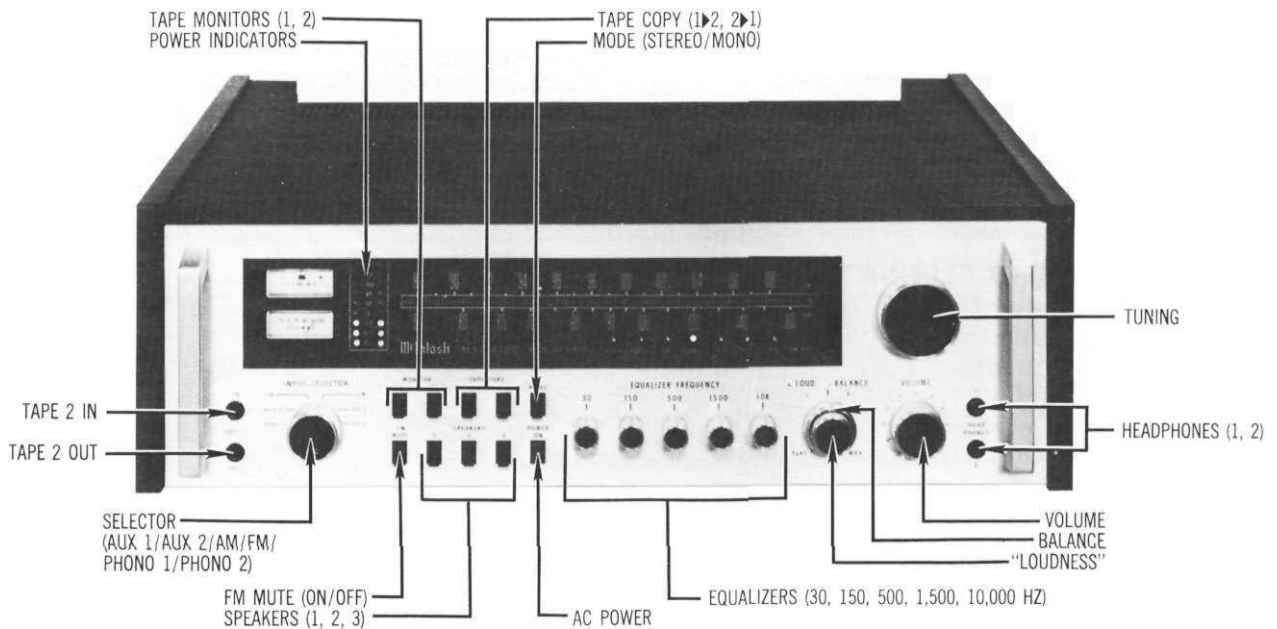

McIntosh's New Receiver: Breeding Tells

Mac 4100 stereo FM/AM receiver, in case with simulated wood-grain finish. Dimensions: 18-5/8 by 5-3/4 inches (front), 14 inches deep plus clearance for controls and connections. AC convenience outlets: 2 switched plus 1 unswitched (600 watts total), 2 for auto-on turntable switching (100 watts total). Warranty: three-year service contract, free with purchase of the receiver, has provisions comparable to typical "limited" warranties but covers normal wear and tear. Manufacturer: McIntosh Laboratory, Inc., 2 Chambers St., Binghamton, N.Y. 13903.

McIntosh has for some years kept a very low profile vis-a-vis the press. This hiatus in communications has fostered a polarization of opinion about McIntosh: Is the company still deserving of its reputation for superb engineering, or is it trading on past glories? One review can't provide a definitive answer, of course, but the Mac 4100 receiver can be taken as a positive sign of health in Binghamton.

The personality of this receiver is like that of an accomplished servant used to coping with pampered aristocrats who

demand the finest but are not always technically knowledgeable or manually dexterous. Accordingly, it takes responsibility in a manner that, paradoxically enough, is unassuming yet quite intolerant of intervention by its master. But once it has taken over, it performs virtually impeccably and can even ward off the consequences of ineptitude without noticeable fuss.

REPORT POLICY Equipment reports are based on laboratory measurements and controlled listening tests. Unless otherwise noted, test data and measurements are obtained by CBS Technology Center, Stamford, Connecticut, a division of Columbia Broadcasting System, Inc., one of the nation's leading research organizations. The choice of equipment to be tested rests with the editors of HIGH FIDELITY. Samples normally are supplied on loan from the manufacturer. Manufacturers are not permitted to read reports in advance of publication, and no report, or portion thereof, may be reproduced for any purpose or in any form without written permission of the publisher. All reports should be construed as applying to the specific samples tested, neither HIGH FIDELITY nor CBS Technology Center assumes responsibility for product performance or quality.

Very little of the receiver's special quality is immediately apparent from the outside, though in hooking it up you get a clue from the convenience outlets. In addition to the conventional switched (black) and unswitched (red) ones, there are two green ones marked TURNTABLE, plus an AUTO/MANUAL switch. If you use the AUTO setting and a turntable plugged into one of the green sockets is turned on, the receiver and any outboarded equipment run off the switched outlets will come on automatically, even when the receiver's power switch is off, and all will turn off again when the turntable shuts down. Thus an automatic model can be made to turn off the whole system unattended. Since the feature works by sensing current draw through the turntable outlets, the switch serves to override it should the turntable be one of those that draw some current even when they are off.

The receiver's switching is handled by DC control voltages, actuated by the front-panel controls and fed to FETs that actually do the signal switching. There are two fundamental advantages to this approach: Switching transients are eliminated, and the short, direct signal paths made possible minimize noise pickup, RFI, and crosstalk. In all of these re-

spects the 4100 is above reproach. We seldom have RFI problems in our area, but we do often find that, for example, some audio from an FM tuner section will "leak" into the tape-monitor signals; none was detectable in the Mac.

The FM section is unusual in that—in addition to conventional automatic stereo/mono switching—it has an automatic-blend feature that progressively reduces stereo separation (and hence out-of-phase noise) as signal strength drops. Since the full audio band is blended, the resulting stereo image may be a bit stabler than in the more usual high-blend solution, but the hiss seems a little more intrusive for a given degree of separation loss. On weak signals it does work, however—and, like so many features of the Mac, without drawing undue attention to itself. Similarly, the Automatic Frequency Lock gently holds onto an FM station that has been tuned correctly; were it not for the front-panel AFL LED, which lights when lock occurs, you would be unaware of its action. This LED acts as a tuning aid; when the muting is on, the LED announces arrival at a receivable station before the unmuting action (which is gentle and slightly delayed) allows any audio to pass. The

McIntosh Mac 4100 Receiver

Tuner Section

Capture ratio	2 dB		
Alternate channel selectivity	76 dB		
THD + N	L ch	R ch	mono
80 Hz	0.25%	0.25%	0.16%
1 kHz	0.17%	0.22%	0.15%
10 kHz	1.8%	1.7%	0.21%
IM distortion	0.06%		
19-kHz pilot	-63½	dB	
38-kHz subcarrier	-66½	dB	
S/N ratio (at 65 dBf)			
stereo	67 dB		
mono	71 dB		

Amplifier Section

Manufacturer's rated power	17¾ dBW (75 watts)/ch.	
Power output at clipping (channels driven simultaneously)		
L ch	20 dBW (98 watts)	
R ch	20 dBW (98 watts)	
Dynamic headroom (at 1 kHz)	1½ dB	
Frequency response	+½i, -¼ dB, 20 Hz to 20 kHz +½, -3 dB, 13 Hz to 35 kHz	
RIAA equalization	± 1 dB, 20 Hz to 20 kHz	
Input characteristics (re 0 dBW (1 watt); noise A-weighted)		
	Sensitivity	S/N ratio
phono 1, 2	0.27 mV	76½ dB
aux 1, 2	30.0 mV	80 dB
tape 1, 2	30.0 mV	80 dB
Phono overload (clipping point)	88 mV at 1 kHz	
Damping factor at 50 Hz	100	

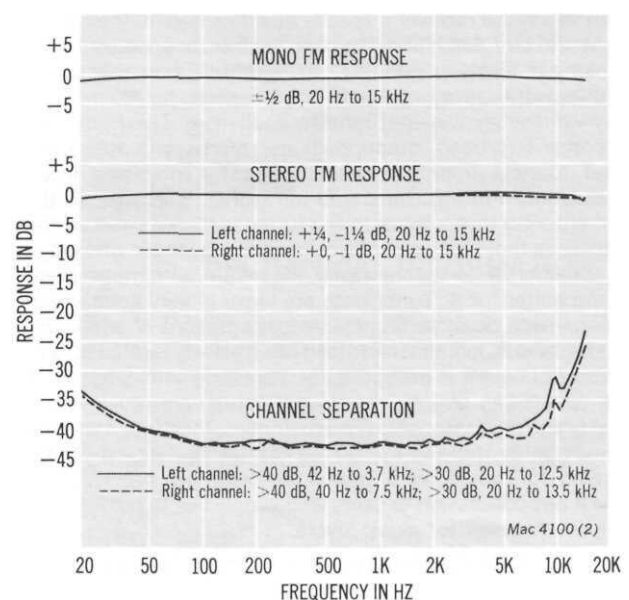
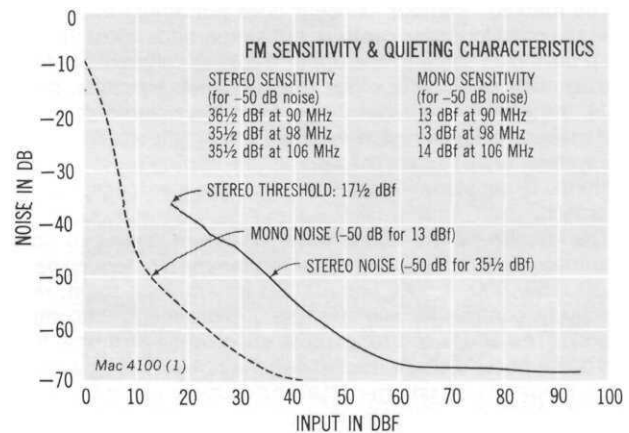

range of the signal-strength meter is well chosen as an aid in antenna orientation for best reception of problem stations.

The amplifier section, too, exemplifies the extra care that sets the receiver apart. Whether the option that enables switching in three speaker pairs simultaneously requires them or not, it has three distinct protection systems. The most conventional is triggered by a heat sensor and shuts down the output until the heat sink has cooled to within safe operating limits. The Sentry Monitor circuit reacts to abnormal current conditions by restricting the drive to the output transistors. And the Power Guard circuit responds to overdrive that normally would create hard clipping by shaving off the potentially dangerous harmonics—"softening" the clipping, so to speak. None impinges on normal operation; all minimize the effects—aural, thermal, or electrical—of abnormal operation.

The Power Guard, for example, limits peaks so smoothly that you are unlikely ever to hear this receiver overload, as such. The top LEDs in the front-panel power display—the one possible concession to fashion in the design—are Power Guard pilots; below that, the display is calibrated from 100 watts down to 0.1 watt in 5-dB steps. As we've said before, we're not convinced of the utility of such indicators, but the calibration points do seem relatively well chosen.

Two unusual features of the front panel are the equalizer/tone controls and the "loudness" knob. The latter might better be marked "contour" since it does not adjust midband level like most loudness controls, but simply adds boost in the deep bass plus some in the upper treble to compensate for low listening levels. Like other separate-knob schemes, this frees the loudness compensation from the volume control and makes it adjustable to the actual listening levels through the system; unlike some, the appropriate setting must be determined by ear alone—which is arguably the most reasonable approach.

The equalizer's five bands have maximum ranges of approximately ± 13 dB and are marked for center frequencies of 30, 150, 500, 1,500, and 10,000 Hz—making them, respectively, controls for subbass, bass, midrange, treble, and sparkle. The 30-Hz control is most effective as a rumble-filter/boom-boost control; the top one might be used as a hiss filter, though its maximum-cut setting dulls the upper treble a good deal. As an ensemble, they offer genuinely useful flexibility; all have detented center "flat" positions.

While the **lab** measurements give little clue to the "extras" from which the receiver's special qualities derive, they document its very solid performance. McIntosh appears to be thinking in terms of listening quality rather than specsmanship (an attitude we applaud), so distortion, for example, is only vanishingly low—not infinitesimally low. The frequency response has been intentionally cut off beyond the audio band to help maintain clean sound by inhibiting intermodulation with infrasonic and ultrasonic "garbage" (a design criterion that applies to the tuner section as well as the amplifier); though this, similarly, may dismay those who judge an amplifier by its square waves, the results with music seem all the better for it. Tuner data are likewise very good—even superb—with no offsetting cause for complaint of any kind.

It is obvious, too, that McIntosh has a clearly formed idea of the sort of user it is designing for; someone who, while he is uninterested in playing the "pro," cares very much about quality and craftsmanship. The cosmetics, the "feel," and the sound quality of the Mac 4100 are all superb; the controls are minimal for the degree of useful flexibility they provide, with little if any concession to users who simply like to putter. This truly is a receiver for music lovers.

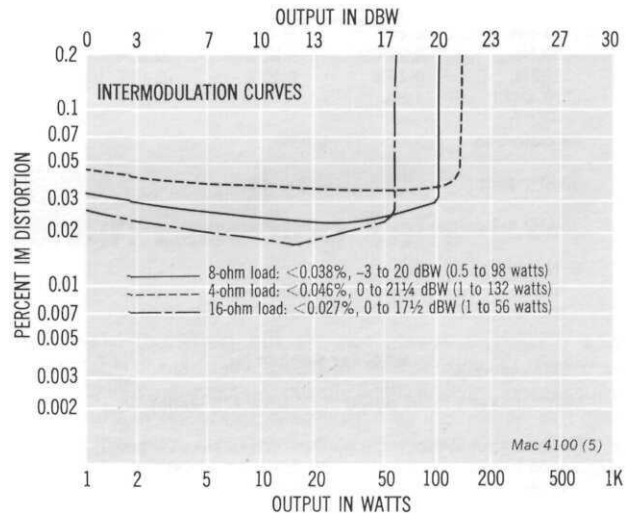
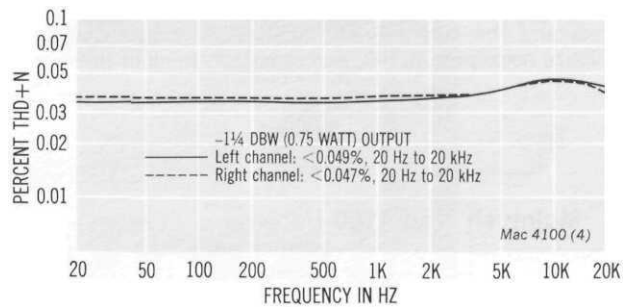
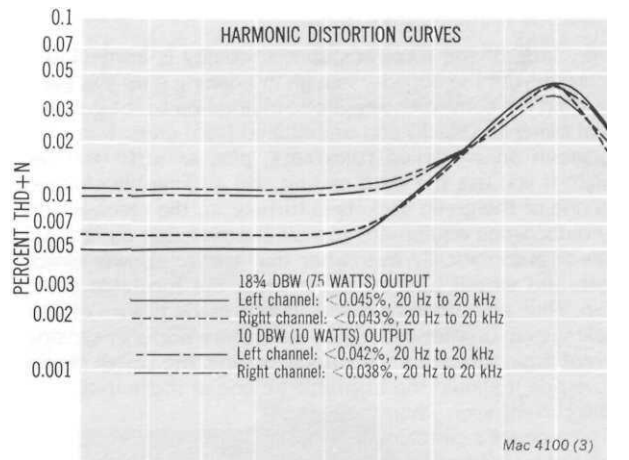

NEW MEASUREMENT STANDARDS

In making comparisons between current reports and those published in the past, readers are cautioned to pay particular attention to the reference levels and similar test criteria cited. S/N ratios for electronics, in particular, are measured very differently now that we have adopted salient features of the new IHF amplifier-measurement standard. While we believe that the new technique (which also implies a saner approach to loading O1 all inputs and outputs) will result in measurements that more perfectly reflect audible, in-use effects, they cannot be compared directly to the numbers resulting from the former, more conventional lab measurements.

HERE IS PERFORMANCE ONCE ONLY OBTAINED
WITH SEPARATE PREAMPLIFIERS
AND POWER AMPLIFIERS

THE McIntOSH MA 6200 STEREO PREAMP-AMPLIFIER

Here's McIntosh performance and quality in a combination solid state preamplifier and solid state power amplifier. It reproduces music accurately with real life definition. Here is the quality power and outstanding flexibility you need to give you the sound of live music in your home.

FEATURES

- High Accuracy Tracking Volume Control
- Five Band Program Tone Shaping Controls
- Power Guard with Indicators
- Switching for Three Pairs of Speakers - all three can be on at once
- Tape Monitor/Copy, for two tape recorders
- Front Panel Tape Jacks
- Continuously Variable Loudness Compensation
- Easy Connections for External Equalizer or Audio Processor
- Speaker Protection Circuits
- LED Function Indicators
- Two Headphone Jacks
- Turn-On Transient Elimination Circuits
- 0.05% Total Harmonic Distortion
- Active Filter Elements
- Triple Shielded Power Transformer
- Electronically Regulated Power Supply
- Current Sensing AC Outlets for "Auto Turn-On" Switched AC Outlets

See page 14 for McIntosh audio power ratings.

PERFORMANCE LIMITS and RATINGS

POWER OUTPUT:

100 Watts minimum sine wave continuous average power output per channel, both channels operating into 4 ohms, 20 Hz to 20 kHz, with no more than 0.05% total Harmonic Distortion

75 Watts minimum sine wave continuous average power output per channel, both channels operating into 8 ohms, 20 Hz to 20 kHz, with no more than 0.05% total Harmonic Distortion

OUTPUT LOAD IMPEDANCE:

4 ohms, 8 ohms

RATED POWER BAND:

20 Hz to 20 kHz

TOTAL HARMONIC DISTORTION:

0.05% maximum at any power level from 250 milliwatts to rated power per channel. 20 Hz to 20 kHz, both channels operating

INTERMODULATION DISTORTION:

0.05% maximum at any power level from 250 milliwatts to rated power per channel with both channels operating for any combination of frequencies 20 Hz to 20 kHz

FREQUENCY RESPONSE:

20 Hz to 20 kHz +0, -0.5 dB at rated power



NOISE AND HUM:

Power Amplifier: 105 dBA, 100 dB unweighted, below rated output; Auxiliary, Tape Input: 100 dBA, 95 dB unweighted, below rated output; Phono Input: 85 dBA, 80 dB unweighted, below 10 millivolts input

DAMPING FACTOR:

Greater than 30

INPUT SENSITIVITY AND IMPEDANCE:

Power Amplifier: 2.5 volts, 22,000 ohms; Tape, Auxiliary: 250 millivolts, 100,000 ohms; Phono: 2 millivolts, 47,000 ohms, 100 pF

TAPE OUTPUT LEVEL:

Auxiliary, Tape: 250 millivolts with rated input; Phono: 250 millivolts with rated input

PROGRAM EQUALIZER:

± 12 dB at 30, 150, 500, 1,500, and 10,000 Hz

GENERAL INFORMATION

SEMICONDUCTOR COMPLEMENT:

42 Transistors; 13 Integrated Circuits; 25 Diodes; 1 Silicon Controlled Rectifier

POWER REQUIREMENTS:

120 Volts, 50/60 Hz, 0.5 to 5 amperes (60 to 480 watts)

MECHANICAL INFORMATION

SIZE:

Front Panel measures 16 inches wide (40.6cm) by 5-7/16 inches high (13.8cm). Chassis measures 14-3/4 inches wide (37.5cm) by 4-13/16 inches high (12.2cm) by 13 inches deep (33.0cm) including PANLOC shelf and back panel connectors. Knob clearance required is 1-1/4 inches (3.2cm) in front of the mounting panel

FINISH:

Front panel is anodized gold and black with special gold/teal nomenclature illumination. Chassis is black

MOUNTING:

McIntosh developed professional PANLOC

WEIGHT:

30 pounds (13.6kg) net. 42 pounds (19.1kg) in shipping carton

THE MCINTOSH CUSTOM EQUALIZER ELIMINATES THE LAST MAJOR SOURCE OF DISTORTION IN YOUR STEREO—YOUR ROOM



MQ 107 Custom Environmental Equalizer

A McIntosh Environmental Equalizer:

- Adjusts for musical balance in your listening room tailored to *your* personal needs •
- Restores musical balance when you move your speakers •
- Restores musical balance if you move to a new room •
- Reduces distortion caused by room construction, materials and dimensions •

McIntosh equalizers are two stereo equalizers in one: the first, programmable filters that correct for listening environment induced musical imbalance, distortion and frequency modification, the second, low frequency compensation for use with superior performing McIntosh loudspeakers.

The room in which you listen affects your listening pleasure by modification of the musical data caused by room resonances, a characteristic of room dimensions; stiffness of room surfaces, a characteristic of the material of which the room is constructed, and distortion, a characteristic of the construction methods. Each filter can be set for frequency and bandwidth and is adjustable for amplitude boost or cut.

Extensive testing of home living rooms and stereo store listening rooms indicates that room dimensions influence the performance of loudspeakers with the most pronounced effects below 250 Hz. Speakers which appear to have no highs and sound "boomy" usually are the victims of a poor listening environment. By eliminating the low frequency peaks caused by room conditions, the highs will appear to be restored and the "boomy" sound will be gone. In many "problem" rooms, the difference with and without the correction is literally night and day.

The McIntosh MQ 104 Environmental Equalizer has fourteen programmable filters that are custom adjusted to restore the desired musical balance and low distortion capability of your stereo. There are seven filters in each channel. Attention to the higher frequency correction is achieved through the High Frequency Compensation controls in each channel. Loudness balance can be restored to the overall musical information with output level controls for each channel.

McIntosh loudspeaker systems have a unique combination of moving or sound producing parts, cabinet, and acoustic damping material. The design relationship of these many elements produces ac-

curate control of the woofer cone motion. Control is achieved in a low frequency radiator by increasing the size and effectiveness of the magnetic structure. This causes the radiator to have a rising response with frequency. The second equalizer circuit (Low Frequency Compensation) provides control to adjust the low frequency response of the McIntosh loudspeaker to 20Hz regardless of placement in your listening room.

In some homes, the acoustical response of the room, when measured with a 1/3 octave acoustical analyzer, will occasionally eliminate the need for compensation. In such rooms where resonance or room gain compensates for much of the rising response of the McIntosh woofer, the programmable filter sections can be used to make any further improvements. In this case, the compensation controls would not be used.

In most rooms, the compensation controls are very useful. The design allows correction for different room gains that occur when the speaker is placed on the floor in a corner, against a wall on the floor away from the corner, or off the floor and away from the corners of the room. The low frequency compensation controls can select from five curves to support these different locations.

Effective corrective adjustments must be made by persons that have knowledge, experience, training expertise and proper 1/3 octave acoustic analyzer equipment.

Your musical pleasure will be fulfilled and your stereo investment protected with the properly programmed McIntosh Environmental Equalizer.



MQ 104 Custom Environmental Equalizer

BULK RATE
U.S. POSTAGE
PAID
Binghamton, N.Y. 13903
Permit No. 7

The continuous improvement of its products is
the policy of McIntosh Laboratory Incorporated,
who reserves the right to improve design without notice.

Printed in U.S.A.